

# INDEX

<b>Section</b>	<b>Description</b>	<b>Page No.</b>
	Tender Notice	2-3
<b>Section-I</b>	Check list/Terms & Conditions For NIT	4-8
<b>Section-II</b>	Instructions to Contractors ( <b>including Reverse Auctioning</b> )	9-20
<b>Section-III</b>	General Terms & Conditions	23-49
<b>Section-IV</b>	Technical Specifications	50-59
<b>Annexure-I</b>	Techno commercial Bid (Annexure A to J)	60-83
<b>Annexure-II</b>	Price Bid	84
<b>Annexure-III</b>	Contract Agreement Form	85

**PUNJAB STATE POWER CORPORATION LIMITED**

Office of The SE/DS City West Circle Ludhiana

Mob: 96461-11523.

E-mail: sewestcircle@gmail.com

Reg. Office: PSPCL Head Office, The Mall, Patiala.

**(NOTICE INVITING E-TENDER)**

1	Tender Enquiry No.	<b>12/West Circle/Ldh/Unit-1 Model Town/2025-26</b>
2	Short Description of Work	Outsourcing of Labour Part for the pilot project to rectify low-lying PVC cables at road/street crossings under Unit-1, Model Town Division in respect of City West Circle, Ludhiana.
3	Estimated Tender Cost	<b>Rs. 167.00 Lacs (Approx.) with GST</b>
4	EMD/PEMD	<b>Valid PEMD of Rs.2.5 Lac Or Earnest money @2% of estimated tender cost subject to a minimum of Rs 5000 and Maximum of Rs 10 Lakhs. However fresh certificate issued during last six months immediately preceding by PSPCL regarding permanent earnest money deposit for executing labour outsourcing works in PSPCL DS offices required.</b> Public Sector undertakings fully owned by the Punjab Government/Central Government/Other State Government shall be exempted from depositing Earnest Money, provided that a certificate of Government Ownership shall be uploaded online for Earnest Money.
5	Tender document cost	Rs.2000/- + Rs.360/- (GST), Total = Rs. 2360/- (Non-Refundable) <b>(To be deposited online)</b>
6	Processing Fee	Minimum Rs. 1000/- to Maximum Rs. 10000/-
7	Start date for downloading of Specification/tender documents from <a href="https://eproc.punjab.gov.in">https://eproc.punjab.gov.in</a>	30-12-2025 at 12:00 hrs
8	Last date for downloading of Specification/tender documents from <a href="https://eproc.punjab.gov.in">https://eproc.punjab.gov.in</a>	15-01-2026 at 17:00 hrs
9	Last date for uploading for Tender documents, Tender documents fee and EMD/PEMD	15-01-2026 at 17:00 hrs
10	Date for opening of tender cost, EMD/PEMD	16-01-2026 at 15:00 hrs
11	Date for opening of Techno-commercial bid	16-01-2026 at 16:00 hrs

Note: - Detailed information regarding tenders can be downloaded from the website <https://eproc.punjab.gov.in>. It is informed that in case tender process is not completed due to any reason, no corrigendum will be published in newspapers. Details regarding corrigendum may be seen on Punjab Govt. website (<https://eproc.punjab.gov.in>).

**SE/DS City West Circle,  
PSPCL, Ludhiana**

ਦਫਤਰ :- ਨਿਗਰਾਨ ਇੰਜੀਨੀਅਰ/ਵੰਡ, ਸ਼ਹਿਰੀ ਪੱਛਮੀ ਹਲਕਾ, ਲੁਧਿਆਣਾ।  
 ਨੋਟਿਸ ਇੰਨਵਾਈਟਿੰਗ ਟੈਂਡਰ (ਈ-ਟੈਂਡਰਿੰਗ ਰਾਹੀਂ)

1.	ਟੈਂਡਰ ਇੰਨਕੁਆਰੀ ਨੰਬਰ	<b>12/West Circle/Ldh/Unit-1 Model Town/2025-26</b>
2.	ਕੰਮ ਦੀ ਕਿਸਮ	ਵੰਡ ਮੰਡਲ ਮਾਡਲ ਟਾਊਨ ਲੁਧਿਆਣਾ ਅਧੀਨ ਪੈਂਦੇ ਯੂਨਿਟ ਨੰ:1 ਅਧੀਨ ਸੜਕ ਅਤੇ ਸਟ੍ਰੀਟ ਕਰਾਸਿੰਗਾਂ ਤੇ ਨੀਵੀਆਂ ਪੀਵੀਸੀ ਕੋਬਲਾਂ ਨੂੰ ਠੀਕ ਕਰਨ ਲਈ ਪਾਇਲਟ ਪ੍ਰੋਜੈਕਟ ਤਹਿਤ ਲੇਬਰ ਆਊਟ ਰਾਹੀਂ ਕੰਮ ਕਰਵਾਉਣ ਹਿੱਤ
3.	ਅਨੁਮਾਨਤ ਲਾਗਤ	<b>167.00</b> ਲੱਖ ਰੁਪਏ ਸਮੇਤ ਜੀ.ਐਸ.ਟੀ
4.	ਜਮਾਨਤੀ ਰਕਮ (via e-payment gateway of GePNIC)	ਕੁੱਲ ਲਾਗਤ ਦਾ 2% ਜਾਂ ਪੱਕੀ ਜਮਾਨਤੀ ਰਕਮ 2.5 ਲੱਖ ਜੋ ਕਿ ਪੀ.ਐਸ ਪੀ.ਐਸ.ਐਲ ਦੇ ਵੰਡ ਦਫਤਰਾਂ ਵਿਖੇ ਲੇਬਰ ਆਊਟਸੋਰਸਿੰਗ ਸਬੰਧੀ ਕੰਮ ਕਰਨ ਲਈ ਜਮ੍ਹਾਂ ਕਰਵਾਈ ਹੋਵੇ ਦਾ ਤਾਜਾ ਸਰਟੀਫਿਕੇਟ। ਜਨਤਕ ਅਧਾਰੇ ਜਿਹੜੇ ਰਾਜ ਸਰਕਾਰਾਂ/ਕੇਂਦਰ ਸਰਕਾਰਾਂ ਦੇ ਅਧੀਨ ਹਨ ਜਿਹਨਾਂ ਨੂੰ ਜਮਾਨਤੀ ਰਕਮ ਜਮ੍ਹਾਂ ਕਰਵਾਉਣ ਤੋਂ ਛੂਟ ਹੋਵੇ, ਸਬੂਤ ਵਜੋਂ ਸਰਟੀਫਿਕੇਟ ਆਨਲਾਈਨ ਅਪਲੋਡ ਕੀਤਾ ਜਾਵੇ।
5.	ਦਸਤਾਵੇਜ਼ਾਂ ਦੀ ਕੀਮਤ	2000/- ਰੁਪਏ +GST18%)= ( ਨਾ ਵਾਪਸੀਯੋਗ) = 2000 + 360= 360/-
6.	ਪ੍ਰੋਸੈਸਿੰਗ ਫੀਸ	ਘੱਟ ਤੋਂ ਘੱਟ 1000/- ਰੁ: ਅਤੇ ਵੱਧ ਤੋਂ ਵੱਧ 10000/- ਰੁ:
6.	ਸਪੈਸਿਫੀਕੇਸ਼ਨ ਡਾਊਨਲੋਡ ਸ਼ੁਰੂ ਕਰਨ ਦੀ ਮਿਤੀ	30-12-2025, ਸਮਾਂ 12:00 ਵਜੇ ਤੱਕ
7.	ਸਪੈਸਿਫੀਕੇਸ਼ਨ ਡਾਊਨਲੋਡ ਕਰਨ ਦੀ ਆਖਰੀ ਮਿਤੀ ਤੇ ਸਮਾਂ	15-01-2026, ਸਮਾਂ 17:00 ਵਜੇ ਤੱਕ
8.	ਸਪੈਸਿਫੀਕੇਸ਼ਨਾਂ, ਟੈਂਡਰਫੀਸ ਅਤੇ ਈ.ਐਮ.ਡੀ/ਪੀ.ਈ.ਐਮ.ਡੀ ਅਪਲੋਡਕਰਨ ਦੀ ਆਖਰੀ ਮਿਤੀ ਤੇ ਸਮਾਂ	15-01-2026, ਸਮਾਂ 17:00 ਵਜੇ ਤੱਕ
9.	ਟੈਂਡਰ ਫੀਸ ਅਤੇ ਈ.ਐਮ.ਡੀ/ਪੀ.ਈ.ਐਮ.ਡੀ ਖੋਲਣ ਦੀ ਮਿਤੀ ਅਤੇ ਸਮਾਂ	16-01-2026, ਸਮਾਂ 15:00 ਵਜੇ ਤੱਕ
10.	ਟੈਕਨੋ ਕਮਰਸ਼ੀਅਲ ਬਿੱਡ ਖੋਲਣ ਦੀ ਮਿਤੀ ਅਤੇ ਸਮਾਂ	16-01-2026, ਸਮਾਂ 16:00 ਵਜੇ ਤੱਕ

**ਨੋਟ :-** ਟੈਂਡਰ ਸਬੰਧੀ ਡਿਟੇਲਡ ਵੇਰਵੇ website <https://eproc.punjab.gov.in> ਵਿੱਚੋਂ ਡਾਊਨਲੋਡ ਕੀਤੇ ਜਾ ਸਕਦੇ ਹਨ। ਜੇਕਰ ਕਿਸੇ ਕਾਰਨ ਟੈਂਡਰ ਪ੍ਰੀਕਿਰਿਆ ਪੂਰੀ ਨਹੀਂ ਹੁੰਦੀ ਤਾਂ ਉਸ ਕੇਸ ਵਿੱਚ ਅਖਬਾਰਾਂ ਵਿੱਚ ਸੋਧ ਪ੍ਰਕਾਸ਼ਿਤ ਨਹੀਂ ਕਰਵਾਈ ਜਾਵੇਗੀ।

ਨਿਗਰਾਨ ਇੰਜੀਨੀਅਰ /ਵੰਡ,  
 ਸ਼ਹਿਰੀ ਪੱਛਮੀ ਹਲਕਾ, ਲੁਧਿਆਣਾ।

## SECTION – I

### 1.1 CHECK LIST OF DOCUMENTS CONSISTING OF TENDER/OFFER.

BIDDER TO ENSURE THAT FOLLOWING DOCUMENTS ARE MANDATORILY UPLOADED WITH THE TENDER FOR IT TO BE COMPLETE: -

Sr No.	Details	To be uploaded with	Remarks
1	Cost of Specification	Part-I	Submit & Upload
2	Processing Fee – Minimum Rs. 1000/- to Maximum Rs. 10000/-	Part-I	Submit & Upload
3	PEMD of Rs 2.5 lakh or Earnest money @2% of estimated tender cost subject to a minimum of Rs 5000 and Maximum of Rs 10Lakhs	Part-I	Submit & Upload
4	EPF &ESI Registration Certificate	Part-II	Upload
5	‘‘A’’ Class Electrical Contractor Certificate from CEI, Punjab.	Part-II	Upload
6	Copy of PAN Card.	Part-II	Upload
7	GST Registration Certificate.	Part-II	Upload
8	<p><b>(i) <u>Proof of Experience:</u></b> Tenderer shall submit proof of experience as a contractor or sub-contractor of having successfully executed similar works of erection of EHT/HT/LT Lines/DTs etc. in PSPCL,PUDA, Railways, NHAI, PWD, Public Sector Undertakings or other Govt/Semi Govt. Organization, Work of CHB <u>as below</u> :</p> <p>1) Experience of above completed work of aggregate value not less than amount equal to 40% of estimated tender cost each in any three years in last seven years <u>i.e.</u> from 2018-19 to 2024-25.</p> <p style="text-align: center;">or</p> <p>2) Experience of above completed work of aggregate value not less than amount equal to 50% of estimated tender cost each in any two years in last seven years <u>i.e.</u> from 2018-19 to 2024-25.</p> <p style="text-align: center;">Or</p> <p>3) Experience of above completed work of aggregate value not less than amount equal to 80% of estimated tender cost each in any one year in last seven years <u>i.e.</u> from 2018-19 to 2024-25.</p> <p>Note:-1. Contractor/Sub contractor shall furnish any of above mentioned Experience certificate of completed work duly signed by Sr.XEN.</p> <p>2.Sub contractor must be authorized by competent authority of PSPCL,PUDA, Railways, NHAI, PWD, Public Sector Undertakings or other Govt/Semi Govt. Organization etc.</p>	Part-II	Upload

9	Proof of enlistment, if registered with PSPCL. If Not, Registration fee as applicable must be deposited before submission of bid.	Part-II	Upload
10	Proof of Bank Solvency equal to 15% of estimated tender cost issued after 01-04-2025	Part-II	Upload
11	Duly audited Annual Financial Reports /Average Annual turnover equal to 30% of estimated tender cost in last three years i.e. 2022-23, 2023-24 & 2024-25 certified by Chartered Accountant along with his UDIN number.	Part-II	Upload
12	Affidavit regarding Non Defaulter of EPF, ESI,GST& Service Tax of last five years (or as applicable) & regarding Non Blacklisting/Debarred of firm by any Govt./Semi Govt./PSU of India, duly attested by Executive Magistrate.	Part-II	Upload
13	Undertaking from the bidder that in case of award of contract to them, they shall furnish Labour License issued from Labour Deptt. Or undertaking regarding Exemption of labour licence before the commencement of work.	Part-II	Upload
14	Undertaking regarding Registration Under Building and Other Construction Worker Act 1996 under Section 7& 12	Part-II	Upload
15	Income Tax Returns of firm as well as Directors/ Partners/ Proprietor of the firm for the latest 3 years.	Part-II	Upload
16	Form 26 AS of the firm for the corresponding years of Experience.	Part-II	Upload
17	Legally valid Authorization signed by Chairman & other Directors of the firm in case of Limited Companies & by all partners in case of partnership firms authorizing the signatory to sign the tender & deal with PSPCL.	Part-II	Upload
18	Contractor/Sub Contractor shall furnish the performance certificate duly signed by Sr.Xen & counter signed by concerned SE.	Part-II	Upload
19	Undertaking regarding unconditional acceptance of all terms and conditions of PSPCL.	Part-II	Upload
20	Undertaking regarding signing of all Tender Documents.	Part-II	Upload

## **1.2 TERMS & CONDITIONS**

- All tender related documents are to be uploaded on website <https://eproc.punjab.gov.in> only. No hard copy will be accepted for processing the tender.
- All bidders must submit & upload cost of tender Specification and Earnest Money equal to the amount as prescribed in the tender documents except in the case of those bidders, who are specifically exempted **via e-payment gateway of GePNIC..**
- Conditional tenders, telegraphic/ e-mailed/ tele-fax tenders, tenders not on prescribed form and tenders without earnest money shall not be accepted.
- In case date of opening happens to be holiday, the tenders shall be opened on the next working day at the same time.
- Tender shall remain valid for 120 days from the date of opening which can be further extended if required with same terms and conditions.
- PSPCL reserves the right to reject any or all tenders without assigning any reasons. In case of any dispute, the decision of the Competent Authority shall be final.
- Rates must be quoted in figures as well as in words.
- The quantities mentioned in the tender specifications can be increased/ decreased as per site requirement with the approval of PSPCL Competent Authority.

- 9 Bidders shall have to comply with all the rules and regulations under Factories Act, Industrial Dispute Act, ESI, EPF Act, Labour Laws, Bonus Act and Workmen's Compensation Act with latest amendments thereof.
10. Bids submitted after the due date and time shall not be accepted.
11. Bids shall be invited through Reverse Auction. However Negotiations if required shall be carried out with L-1 Bidder.
12. The Bidders shall upload all the documents at the time of submission of bid:
  - (i) Proof of valid "A" Class Electrical Contract Certificate from CEI Punjab.
  - (ii) Copy of PAN CARD.
  - (iii) Proof of EPF Registration Certificate.
  - (iv) Undertaking regarding Registration Under Building and other construction worker Act 1996 under Section 7& 12
  - (v) Proof of ESI Registration Certificate.
  - (vi) Proof of GST Registration Certificate.
  - (vii) Affidavit regarding Non Defaulter of EPF, ESI,GST& Service Tax of last five years (or as applicable )& regarding non Blacklisting/debarred of firm by any Govt./Semi Govt./PSU of India duly attested by Executive Magistrate.
  - (viii) Every bidder shall upload along with his tender, bank solvency certificate of amount not less than 15% of Estimated Tender Cost issued after 01-04-2025.
  - (ix) Proof of enlistment if registered with PSPCL. If Not, Registration fee as applicable must be deposited before submission of bid.
  - (x) Duly audited Annual Financial Reports /Average Annual Turnover equal to 30% of Estimated tender cost in last three years i.e. 2021-22,2022-23,2023-24 certified by Chartered Accountant along with his UDIN number.
  - (xi) Form 26 AS of the firm for the corresponding years of experience.
  - (xii) Income Tax Returns of firm as well as Directors/ Partners/ Proprietor of the firm for the latest 3 years.
  - (xiii) Undertaking from the bidder that in case of award of contract to them, they shall furnish Labour License issued from Labour Deptt.,or undertaking regarding exemption of labour license before the commencement of work
  - (xiv) Legally valid Authorization signed by Chairman & other Directors of the firm in case of Limited Companies & by all partners in case of partnership firms authorizing the signatory to sign the tender & deal with PSPCL.

**Proof of Experience:**

Tenderer shall submit proof of experience as a contractor or sub-contractor of having successfully executed similar works of erection of EHT/HT/LT Lines/DTs etc in PSPCL,PUDA, Railways, NHAI, PWD, Public Sector Undertakings or other Govt/Semi Govt. Organization, Work of CHB as below :

1) Experience of above completed work of aggregate value not less than amount equal to 40% of estimated tender cost each in any three years in last seven years i.e. from 2018-19 to 2024-25.

or

2) Experience of above completed work of aggregate value not less than amount equal to 50% of estimated tender cost each in any two years in last seven years i.e. from 2018-19 to 2024-25.

or

3) Experience of above completed work of aggregate value not less than amount equal to 80% of estimated tender cost each in any one year in last seven years i.e. from 2018-19 to 2024-25.

Note:-

1. Contractor/Sub contractor shall furnish any of above mentioned Experience certificate of completed work duly signed by Sr. XEN .
2. Sub contractor must be authorized by competent authority of PSPCL, PUDA, Railways, NHAI, PWD, Public Sector Undertakings or other Govt/Semi Govt. Organization etc.
3. Only labour portion of works which are successfully executed shall be considered for evaluating experience of Tender.
4. In case Bidders upload the experience of successfully executed works and if same are of "Turn Key Basis" ,then only labour portion of such works will be considered for evaluating the experience of Bidders which should be specifically mentioned/segregated in experience certificate issued by the concerned department. In case labour part in not mentioned in the experience certificate, 20% of works executed on turnkey basis "shall be considered as labour portion"
5. The experience certificate must be issued, not below the rank of Addl.SE/Sr. XEN or equivalent Rank & counter signed by concerned SE as per Annexure H.
6. The contractor/executing agency itself will be fully responsible for any type of damage to the material or to the work due to accident or natural calamity.
7. The onus of responsibility in case of death or injury to the labour/ worker during the work or at the time of execution of work will fully lie with the contractor / executing agency. PSPCL shall bear no responsibility /claim in this regard whatsoever.
8. The bidders must convey unconditional acceptance to the PSPCL's terms and conditions, failing which their bid is liable to be rejected.
9. Time to complete a specific works will be one month or as specified in work order subject to availability of material.
10. Work can be allotted Sub Division Wise or feeder wise.
11. The Bidder has to quote premium offered on PSPCL Scheduled Labour Rates for various activities to be carried out by him.
12. The rates quoted by the contractors shall remain operative for year 2025-26 for all the works to be executed in the Divisions. However, the rates shall also be operative during the extended period of tender.
13. Amount will be paid into the Bank account.
14. Whether a firm/contractor is registered with PSPCL, shall upload proof of registration. If not, Registration fee as applicable must be deposited before the last date of uploading tender.
15. EMD and Tender fees will be paid only through online and net banking mode for PEMD certificate contractor needs to select exemption option.

**1.3 OTHER TERMS AND CONDITIONS: -**

1. All the terms and conditions specified in the NIT and in the different sections of the tender specification shall be applicable on the contractor and form the part of the contract agreement.
2. TDS (Income Tax)& TDS (GST)as applicable at the time of making payment will be deducted from the total value of the work done.
3. Security shall be deducted at the rate of 5% of work done from each Running Bill. Earnest Money already deposited shall be adjusted against the security deposit. In case of PEMD, full Security deposit will be deducted from the bills.
4. Works will be executed as per PSPCL/ Govt. instructions/guidelines.
5. Statutory deductions shall be made as per PSPCL/ Govt. instructions.

6. Labour cess will be deducted @1% of work done for each running and final bill (if applicable).
7. If the contractor fails to execute the work up to the stipulated time period, penalty of 0.5% of the estimated cost of the whole work remaining unfinished per week shall be imposed upon the contractor subject to the maximum of 10% of the total cost of the work order till the completion of work.
8. All legal proceedings relating to the work shall be in the territorial jurisdiction of Distt. Court Ludhiana.
9. The rates quoted by the contractor shall be inclusive of all taxes and charges etc.
10. No claim on account of fluctuations of prices due to war/ any other cases shall be accepted. No claim for any labour rendered idle on account of stoppage of work or any other reason shall be accepted.
11. All manpower deployed by the contractor should be familiar with electrical lines and no person should be deployed less than 18 years of age and more than 60 years of age.
12. Any excess payment made to the contractor inadvertently or otherwise under this contract or on any account what-so-ever in respect of this contract or any other contract may be deducted from any sum what-so-ever payable by the PSPCL to the contractor either in respect of this contract or any other allotment letter of contract or on any other account and in any office of the PSPCL.
13. The contractor shall be responsible for making his own arrangement for priorities of licenses/royalty and T&P etc.
14. The work should be executed as per standard design of PSPCL.
15. The work of contractor would be done under the supervision of certified electrical supervisor.
16. The work may be inspected by the Chief Electrical Inspector of Punjab Govt. CEI inspection fees will be deposited by the PSPCL. If any defect/ discrepancy pointed out by the CEI in his inspection report, the same will be rectified by the contractor at his own cost and no additional payment shall be borne by the PSPCL.
17. The contract agreement shall be signed on a non-judicial stamp paper worth Rs.500/- (Cost of which will be borne by the contractor) within 7 days of the date of issue of allotment letter.
18. Only labour portion of works which are successfully executed shall be considered for evaluating experience of Tender.
19. In case Bidder upload the experience of successfully executed works are of " Turn Key Basis " then only labour portion of such works will be considered for evaluating the experience of Bidder which should be specifically mentioned/segregated in experience certificate issued by the concerned department.
20. In absence of non-mentioned labour part in the experience certificate, 20% works executed on turn key basis "shall be considered as labour portion.
21. The specimen of works executed experience certificate (not issued below the rank of Addl. SE/Sr. Xen concerned or equivalent Rank & counter signed by concerned SE) as per Annexure-H shall be acceptable.
22. Time period of the Tender can be increased or decreased at the discretion of PSPCL.
23. PSEB, Now PSPCL works regulation 1997 ammended from time to time will be applicable which can be downloaded from [www.pspcl.in](http://www.pspcl.in)

**SE/DS City West Circle,  
PSPCL Ludhiana.**

SECTION – II  
INSTRUCTIONS TO CONTRACTORS

**A. Definitions**

In this Specifications (including all the Appendices), unless the context otherwise requires, the terms given below have the following meanings assigned to them.

1. “Contractor” shall mean the lead firm / party whose quotes against an enquiry.
2. VENDER/ Contractor shall mean the successful CONTRACTOR whose offer has been accepted by the OWNER/PURCHASER and on whom the `Contract` or `Purchase Order` is placed by the OWNER/PURCHASER and shall include his heirs, legal representatives, successors and permitted assigns, approved by the Company-in-Charge.
3. “Inspector” shall mean the authorized representative appointed by the OWNER/PURCHASER for the purpose of inspection of material/ Equipment/ Works.
4. “Manufacturer” refers to a person or firm who is the producer and furnisher of material or designer and fabricator of equipment to either the OWNER/PURCHASER or the VENDOR/ CONTRACTOR or both under the `Contract`
5. “Month” shall mean calendar month
6. “Specification” shall mean collectively all the terms and stipulations contained in those portions of the `Contract` known as General Conditions, the specifications and such Amendments, Revisions, Deletions or Additions, as may be made in the Agreement and all written agreements made or to be made pertaining to the method and manner of performing the work or to the quantities and qualities of the materials to be furnished under the `Contract`
7. “Addendum” In addition to Specifications (RFP) document, any other document issued to the contractors by PSPCL in the context of this offering process
8. “Offer” shall mean the proposal/document that the CONTRACTOR submits in the requested and specified form in the `Specification`
9. “Offering Entity” Where the Contractor brings respond to this offer process
10. “Plant” or “Equipment” and “Work” shall mean respectively the goods or “Works” to be supplied and services to be provided by the VENDOR/ CONTRACTOR/ FABRICATOR under the `Work Order` or `Contract`
11. “Contract” or Work Order shall mean the order and associated specification executed by the Owner/ Purchaser and the VENDOR/ CONTRACTOR including other documents agreed between the parties or implied to form a part of the `Contract`
12. “Contract Price” shall mean, if there is formal agreement, the prices referred to in the agreement or if there is no formal agreement, the price agreed to be the value of the `Contract`
13. “Date of Contract” shall mean the calendar date on which the OWNER / PURCHASER and VENDOR / CONTRACTOR have signed the `Contract`. “Contract Period” shall mean the period during which the `Contract` shall be executed as agreed between VENDOR/ CONTRACTOR/ FABRICATOR and OWNER/ PURCHASER in the `Contract`
14. “Guarantee Period” shall mean the period during which the `Plant` or `Equipment` shall give the same performance as guaranteed by the VENDOR in the Schedule of Guarantee as in the Specification
15. “Approved” and “Approval” wherever used in the `Specification` shall mean, respectively, approved by and approval of the OWNER/PURCHASER. When the words `Approved`, `Approval`, `Subject to Approval`, `Satisfactory`, `Equal to`, `Proper`, `Requested`, `As Directed`, `Where Directed`, `When Directed`, `Determined by`, `Accepted`, `Permitted`, or words and phrases of like import are

- used, the approval, judgment, direction, etc. is understood to be a function of the OWNER/PURCHASER
16. "Commercial Use" shall mean that use of the 'Equipment' or Work which the contract contemplates of that for which 'Equipment' or 'work' is commercially capable
  17. "Government" shall mean Government of Punjab State
  18. "Instruction" shall mean any drawings and/or instruction in writing, details, directions and explanations issued by the OWNER/PURCHASER from time to time during the 'Contract Period'
  19. "Business" means Electricity Distribution and Revenue Collection.
  20. "Companies Act" means Companies Act, 1956 (as amended)
  21. "Goods/ Services" All the equipment, machines, materials and services which the successful contractor is required to provide to PSPCL, under the Contract.
  22. "Letter of Intent (LOI)" Written communication to the successful contractor regarding PSPCL'S intention to sign Contract with them to fulfil the requirements of Specifications (RFP)
  23. "Project" Design, Development, Supply & Installation of Hardware, Software, Networking Equipment, Training and Implementation of ERP and/or Application Packages for online integration of Distribution and Transmission Business of the PSPCL
  24. "PSPCL" means Punjab State Power Corporation Limited.
  25. "Specifications (RFP) Documents" All the documents issued to the contractor.
  26. "Work Order" Written Order signed by PSPCL after the successful contractor has accepted the LOI. This along with LOI, Specifications (RFP) document and the contractor's response to RFP shall constitute part of the Contract.
  27. "PSPCL/Owner/Purchaser" shall in general mean Punjab State Power Corporation Limited on whose behalf the enquiry is issued and shall include their successors and assigns, as well as his authorized officers/representatives. However, in particular cases where term is used in reference of being any competent authority for any decision or discretion to decide/ interpret, it means EIC/ CE DS Central Zone PSPCL Ludhiana.
  28. "Notice in Writing" or "Written Notice" shall mean a notice, in written, typed or printed characters sent (unless delivered personally or otherwise proved to have been received) by registered post to the last known private or business address or registered office of the addresses and shall be deemed to have been received when in ordinary course of post, it would have been delivered
  29. "Contractor's Works" or "MANUFACTURER'S Works" shall mean and include the land and other places which are used by the VENDOR for the manufacture of Equipment or performing the "Works"
  30. "Performance Tests" shall mean such tests as are prescribed in the "Specification", to be performed by the VENDOR in a lab environment before the equipment/ software application is taken over under guarantee by the OWNER/PURCHASER.
  31. "Drawings " shall mean all Drawings furnished by the OWNER/ PURCHASER or the CONSULTANT as a basis for Proposal Supplementary drawings furnished by the OWNER / PURCHASER to clarify and to define in greater detail the intent of the "Contract" Drawing submitted by the VENDOR with his proposal provided such drawings are acceptable to the OWNER/PURCHASER. Drawings furnished by the OWNER/PURCHASER to the VENDOR during the process of the work; and Engineering data and drawings submitted by the VENDOR during the progress of the work provided such drawings are acceptable to the OWNER/PURCHASER.
  32. "Award of contract" shall mean the issue of the work order or the Letter of Intent, whichever is earlier.

33. “Nodal Officer” means the officer duly appointed by the purchaser.

**1. Scope of Work (Pilot Project) :**

- a) The Scope of Work is to Outsourcing of Labour as per following:
- 1) Replacement of low-lying PVC at road crossings with 4-core cables and re-locations of MCB’s.
  - 2) To maintain line symmetry and proper ground clearance, replace existing 8-meter PCC poles with 9-meter PCC poles.
  - 3) Dismantlement of idle old poles and damaged/unused PVC/Network wire.
  - 4) Re-sagging of LT/HT Lines.
  - 5) Relocation of Poles which are causing hindrance to public in general.
  - 6) Replace 1/1 MCB near road crossings with 4/1 MCB to reduce congestion of PVC cables.
  - 7) Replacement of multiple 4 core road crossing cables with single higher size 4 core cables.
  - 8) Providing distribution/junction boxes for service cables on poles.
  - 9) **The Works at labour rates for all distribution works. The work consists of various smaller jobs/sub-works. The concerned office will issue the sub-work order/Job order along with detailed estimate & drawings to the contractor and he will complete the sub-work within the stipulated time and submit measurement/bill. PSPCL may issue the material of same job/sub-work in number of lots to the contractor and nothing extra on this account will be payable**
  - 10) Any other labour work related to provide better electrical clearance.
  - 11) The **following 35 no.11** Kv feeders have been identified and are considered for inclusion in pilot project.

Sr.No.	No. Of 11 Kv Feeders	No. of Tentative DT’s	No. of Tentative Crossings (Approx.)
1	35 Nos	-	1575

- b) All material required for the execution of the work will be supplied by the PSPCL and contractor will have to do the labour part only.
- c) The requisite T&P required for carrying out the work is in scope of the contractor and nothing extra is payable.
- d) Dismantled material shall be reused where provided in the estimate.
- e) Surplus dismantled material if any will be handed over to the PSPCL.
- f) This specification covers the provision of labour component for erection and fabrication only (of DT bed, G.O. Switch base, MS members and clamps for erection of lines etc.) Fabrication like cutting, drilling etc. required for the distribution of work
- g) Work will be executed Operation Sub Division wise or Sub Section wise/estimate wise and work permits shall be arranged by concerned DS officers/officials and due safety precautions will be taken by the contractors (through supervisor duly licensed by CEI Punjab) during the work. The contractors shall execute work in such a fashion that supply to customers is not disturbed unnecessarily. Press note for planned shutdowns will be issued by the concerned PSPCL officer.

**h)** Dismantled material if any shall be returned by the Contractor to store within 15 days of the completion of work through JE concerned. Transportation shall be provided by the Contractor without any extra cost.

**i) Detail of Package of N.I.T**

Sr. No.	Name of Division	Amount ( In lacs) WITH GST
1)	Unit-1, Ds Division Model Town, Ludhiana	167.00
<b>Total(Approx.)</b>		<b>167.00</b>

**1.1 COMPLETION PERIOD**

**The contractor must ensure the completion of work within time period as specified in the work order. In case last SR is issued after the above specified completion period, then the completion report shall be deemed to be extended by 15 days after the issue of last SR.** PSPCL may extend the scope of work by extending the quantities offered to the contractor, where he carries the work at the faster pace. Similarly if the contractor fails to maintain the required pace of the work, his scope may be reduced (by reducing the quantities and offering the same to any other contractor) by the Competent Authority of PSPCL. However reducing the scope of work will not absolve the contractor from his liability to face penalty or recession of contract as per the applicable clause of this specification.

**Note:** Every contractor shall ensure that proportionate progress of works in terms of total value of work order placed upon him and has to complete the job orders within stipulated time. In case he fails to do so; he shall be served with a registered notice to make up the lag in progress within 10 days from the date of issue of notice otherwise PSPCL reserves the right to cancel the work order. However penalty for delay in work shall be applicable as per clause **3.15 of Section-III (Part-3).**

The sketches of the existing LD system are to be supplied by the concerned Sr. XEN DS. Contractor will carry out a joint survey of all sketches for verification during mobilization period only, which must be signed by contractor and countersigned by concerned AE/AEE DS, in token of verification. If during the joint survey any sketch is changed, the same will be got re-authenticated from concerned ASE/Sr. XEN/ DS Division. After verification, sketches will be handed over to the contractor for execution of works.

**1.2 FINAL CHECKING, TESTING AND COMMISSIONING**

After completion of works, final checking of network shall be done by the PSPCL's officer or its authorized agency to ensure that all the works executed have been done according to specification approved by PSPCL. All the works shall be thoroughly inspected keeping in view the PSPCL specifications.

**1.3 COMPLETION PERIOD OF CONTRACT**

Time to complete the works against tender will be 3 months and same can be increased/decreased at the discretion of PSPCL. Further time period to complete specific job shall be three month which includes mobilization period also. The contractor/firm shall start work immediately or within seven days from the issue of work order in their favour subject to availability of requisite material needed for the work and in case of release of connections. The contractor will complete the work within required period of time as per supply code regulation 8.

**2. Cost of Offer**

The Contract or firm shall bear all the cost and expenses associated with preparation and submission of its Offer including post Offer discussions, technical and other presentation etc. and Owner will in no case be responsible or liable for those costs, regardless of the conduct or outcome of the whole process.

### **3. One Offer per Bidder**

Each bidder shall **submit only one Offer by himself**, or as a partner in a firm.

### **Clarifications on Offer documents**

- 4.1 If the prospective Bidder finds discrepancies or omission in the specifications and document or is in doubt as to the true meaning of any part, he shall at once make a request, in writing, for any interpretation/clarifications to the Authority inviting Tender. The Authority inviting tender then will issue interpretations and clarifications as he may think fit in writing. After receipt of such interpretations and clarifications, the Bidder may submit his Offer but within the time and date as specified in the invitation to Offer. All such interpretations and clarifications shall form a part of the Specification document and shall accompany the Bidder's proposal.
- 4.2 Verbal clarifications and information made by the Bidder or his representative shall not in any way be binding on the Authority Inviting Tender.

### **Amendment for Specification Documents.**

- 5.1 At any time prior to the deadline for submission of Offers, the PSPCL may, for any reason, whether at its own initiative or in response to a clarification required by a prospective bidder, modify the Specification Documents by amendment(s).
- 5.2 The amendment will be notified in writing or by Fax/E-mail or cable to all prospective Bidder, which have received the Specification Document at the address contained in the letter of request for issue of Specification Document from the Bidders. Authority Inviting Tender will bear no responsibility or liability arising out of non-receipt of the same in time or otherwise.
- 5.3 In order to afford prospective bidder reasonable time in which to take the amendment into account in preparing their Offers, the Owner may, at its discretion, extend the deadline for the submission of Offers.
- 5.4 Such amendments, clarifications etc. shall be binding on Bidders and will be given due consideration by the Bidders while they submit their Offers and invariably enclose such documents as a part of the Offer.

### **6. Language of Offer**

The Offer prepared by the bidders and all correspondence and documents relating to the Offer, exchanged by the Bidders and the Owner, shall be written in the English language.

### **7. Local Conditions**

- 7.1 It will be imperative on each Bidder to fully inform himself of all local conditions and factors, which may have any effect on the execution of the Contract covered under these documents and specifications. The Owner shall not entertain any request for clarifications from the Bidders, regarding such local conditions.

7.2 It must be understood and agreed that such factors have properly been investigated and considered while submitting the proposals. No claim for financial adjustment to the Contract awarded under these specifications and documents will be entertained by the Owner. Neither any change in the time schedule of the Contract nor any financial adjustments arising thereof shall be permitted by the Owner, which are based on the lack of such clear information or its effect on the cost of the Works, to the Contractor.

## 8. Documents Comprising the Offer

The Bidder shall complete the Offer Form inclusive of Price Schedules; Acceptance to Offer Document conditions and standard specifications and qualification requirement documents.

## 9. Contract Quality Assurance

The Bidder shall include in his proposal the Quality Assurance Programmers containing the overall quality management and procedures, which he proposes to follow in the performance of the Contract during various phases as detailed in relevant Clauses of the technical specification.

## 10) Offer Price

- 10.1 Price offered for each item in the Offer form are firm and are negotiable. The prices shall be valid for the full period of the contract and also for the extended period.
- 10.2 The bidder shall sign the offer in token of his acceptance.
- 10.3 The prices offered are in Indian Rupees.
- 10.4 No mobilization advance shall be paid to the successful contractor, as such the same shall not be considered in the Offer.
- 10.5. Discount on the Offered price shall also be accepted. In case there are more no. of eligible bidders, the work shall be allotted on the basis of technical merit and no commercial bidding/ discounts shall be accepted. Competent Authority shall be competent to allot the work on the basis of technical merit or (divide the work among the eligible contractors) and to judge the technical merit.

## 11) REVERSE AUCTIONING (RA)

The following procedure and terms & conditions shall be applicable for Reverse Auction in PSPCL:-

- In case the no. of bidders are more than 3, the H1 (Highest) bidder shall not be eligible to participate in further process of the tender and his tender shall be rejected.
- All the Bidders shall be assigned a unique user name and password by e-tendering agency of PSPCL. Bidders are advised to change the password after the receipt of initial password from PSPCL to ensure confidentiality. All bids made from Login IDs assigned to bidders shall be deemed to have been made by bidders/bidders' company/bidders' authorized representatives.
- Bidders shall be required to submit their acceptance to the stipulated terms and conditions before participating in the R.A.
- Online Reverse Auction shall be conducted by PSPCL on pre-specified date and time for duration of 1 Hour. The bidders may quote the bids from their own offices /place of their choice. Internet connectivity is to be ensured by bidders themselves.

- All bidders are required to submit their price bid along with submission of Techno-commercial bid as per schedule. Only those bidders who submit their original bids within the scheduled time and who are considered technically and commercially eligible, shall be eligible to participate in RA process.
- The 'Opening Price' i.e. start price for RA shall be decided by PSPCL. Bid Decrement shall be 0.1% of L-1 Bid Price obtained against a particular tender enquiry upon the opening of Price Bid of tender.
- Bidders shall be able to view the following on their screen along with the necessary fields during Online Reverse Auction:-
  - a) Start Price
  - b) Decrement Value
  - c) Rank of the bidder
  - d) Current Bid value of the Bidder (Total Bid Price)
  - e) Best bid in the Auction (Current L1 price)
  - f) Next Valid Bid (Total Bid Prices to be quoted in order to become L1)
  - g) Minimum Bid Price (Bidder to enter his minimum Bid Price here)
- Bidder may become 'L1 Bidder' by offering a price equal to or lower than the 'Next Valid Bid' and this shall continue as an iterative process.
- Auction Extension Time: If a valid bid is placed within 5 minutes of End Time of the RA, then Reverse Auction duration shall get automatically extended for another 5 minutes from the existing end time. It may be noted that the auto extension will take place if a valid Bid comes in those last five minutes. If a bid does not get accepted as the lowest Bid, the auto-extension will not take place even if the bid might have come in last five minutes. The above process shall continue till no valid bid is received in last 5 minutes which shall mark the completion of reverse auction. The bidders are advised not to wait till the last moment to enter their bid so as to avoid complications related to internet connectivity, network problems, system crash down, Power failure etc. No request for extension in time period of RA due to any of the above reasons shall be entertained by PSPCL.
- If no bid is received within the specified time duration of the online RA, then PSPCL shall reserve the rights to scrap the online RA process and proceed with the L-1 Bid Price received through e-tendering for further processing.
- After completion of online Reverse Auction, the Closing Price (CP) shall be considered as L1 rate for further processing including negotiations (if required). Based on the final price quoted by bidders, the successful bidders shall be required to submit summary of Final Price in prescribed format (Summary of Final Price-Reverse auction, Uploaded by PSPCL in Excel Sheet) within 2 working days of conclusion of the RA. In case a bidder fails to submit the above Summary, then it may lead to cancellation of bid and call for action against the bidder which may include forfeiture of EMD/PEMD and suspension of business dealings etc.
- Proxy Bids: Proxy bidding feature is a pro-bidder feature to safeguard the bidders' interest in event of internet failure or to avoid last minute rush. The proxy bidding feature allows bidder to place an automated bid in the system directly in an auction and bid without having to enter a new amount each time a competing bidder submits a new offer. The bid amount that a bidder enters is the minimum bid price that the bidder is willing to offer. Here, the software shall automatically bid on behalf of the bidder who has quoted the lowest "Minimum Bid Price", the price which is one decrement less than the next bidder's bid price. This obviates the need for the bidder participating in the bidding process until the minimum bid amount is detrimentally reached by other bidders. When any bidder quotes a price lower than the existing lowest bid amount, the bidder (who had earlier submitted lowest proxy bid) has an option to once again start participating in the bidding process by quoting a price equal

to or lower than the next valid bid price. However it may please be noted that if the current bid matches the minimum bid of the lowest bidder submitted earlier, the bid submitted by the lowest bidder will be recognized as the L1 at that instant.

During the course of bidding, the bidder shall not be able to delete or increase the proxy bid amount but can always reduce the same depending upon the amount quoted by other bidders. Proxy bids are fed into the system directly by the respective bidders. As such this information is privy only to the respective bidder(s).

**NOTE:** The procedure/system of “Proxy Bids” will only be followed if the e-tendering software system supports it.

- PSPCL shall reserve the rights to cancel/reschedule the RA process/ tender at any time, with due intimation to all concerned, without assigning any reason.
- Other terms and conditions shall be as per bidder’s Techno-Commercial offers and as per PSPCL's bidding documents and other up to date correspondence (if any).

## **12) Taxes and Duties**

- 12.1 The rates allowed for labour are inclusive of all applicable taxes except GST which as applicable shall be paid extra. Any tax is levied by the Govt. after the acceptance of this offer have any additional burden on the work, shall be paid extra by the PSPCL on actual basis. The successful contractor after completion of work shall give a certificate that GST charged from PSPCL has been paid to the concerned authorities including his self-manufactured items.
- 12.2 As regard the Income Tax, surcharge on Income Tax and other taxes including tax deduction at source, the Contractor firm shall be responsible for such payment to the concerned authorities.

## **13) Offer Validity**

- 13.1 The Offers as submitted should be valid for acceptance for at least 120 days from the date of opening of offers, unless specified otherwise.
- 13.2 In exceptional circumstances, prior to expiry of the original Offer validity period, the Owner may request the Contractor firm to extend the period of validity for a specified additional period. The request and the responses thereto shall be made in writing or by fax. The contractor firm may refuse the request without forfeiting its offer security. The Contractor agreeing to the request will not be required or permitted to modify his Offer, but will be required to extend the validity of his Offer for the period of the extension.

## **14) Format of Offer**

- 14.1 The offers shall be submitted in Three parts i.e. Part-I consisting of EMD and Cost of documents, Part-II consisting of Techno Commercial part and Part III consisting of Price bid.

## **15) Deadline for Submission of Offers.**

The offers shall be submitted in Three parts i.e. Part-I consisting of EMD, Part-II consisting of Technical Specifications and Part III offered Prices (and accepted by the contractor).

## **16) Clarification of Offers.**

To assist in the examination, evaluation and comparison of Offers, PSPCL may at its discretion, ask the bidder for a clarification of its Offer. The request for clarification and the response shall be in writing and no change in the price or substance of the Offer shall be sought, offered or permitted.

**17) Examination of Offers.**

17.1 The owner will examine the offers to determine whether these are complete, whether any computational errors have been made, whether required sureties have been furnished, whether the documents have been properly signed, and whether the Offers are generally in order.

17.2 The price furnished (unit price & total price) for various price schedules should be consistent with each other. In the case of any inconsistency in the unit price and total price for any item; the unit price will be considered for the purpose of examination & comparison of offers. If there is any inconsistency in furnished price in words and figures, the amount quoted in words will be considered for the purpose of examination & comparison of offers, but the Owner shall be entitled to rectify arithmetic error by considering the lowest of the two for awarding the contract if the contractor otherwise also happens to be the lowest contractor.

**18) Comparison of Offers.**

The Offers shall be evaluated on the basis of technical merit of bidders. Technical merit will come in to picture only after the qualifying criteria are met and it consists of the turnover/ working experience (in the relevant or similar field) of the contractors.

**19) Contacting the Owner**

Offers shall be deemed to be under consideration immediately after they are opened and until such time official intimation of award / rejection is made by the PSPCL to the bidders. While the Offers are under consideration, Bidders and/or his representatives or the interested parties are advised to refrain from contacting by any means, the Owner and/or his employees/representative on matter related to the Offers under consideration. The Owner, if necessary, will obtain clarifications on the Offers by requesting for such information from any or all the Bidders, in writing Bidders will not be permitted to change the substance of the Offers after the Tender have been opened. Any effort by a Bidder to influence the purchaser in any way may result in rejection of the Bidder's Offer.

**20) Award Criteria**

20.1 The PSPCL can award the Contract Division/ sub division wise to the Bidder/ Bidders whose offer has been determined to be substantially responsive and the Bidder determined to be qualified to perform the contract satisfactorily as decided by Competent Authority of PSPCL.

20.2 Further, the PSPCL reserves the right to award separate Contracts to two or more parties in line with the terms and conditions specified in the accompanying Technical specifications.

**NOTE :-** In case there are more no. of eligible bidders, the work shall be allotted on the basis of technical merit and no commercial bidding/ discounts shall be accepted. Competent Authority shall be competent to allot the work on the basis of technical

merit or (divide the work among the eligible contractors) and to judge the technical merit.

**21) Owner's right to accept any Offer and to reject any or all Offers**

The Owner reserves the right to accept or reject any Offer, and to annul the whole process and reject all Offers at any time prior to award of Contract, without thereby incurring any liability to the affected Bidder or Bidders or any obligation to inform the affected Bidder or Bidders on the grounds for the Owner's action.

**22) Notification of Award (Issue of LOI)**

22.1 Prior to the expiration of the period of Offer validity and extended validity period, if any, the Owner will notify the successful Bidder in writing by registered letter or by email or Fax, to be confirmed in writing by registered letter, that his Offer has been accepted.

22.2 The notification of award will constitute the formation of the Contract.

**23) Signing of Contract**

23.1 At the same time as the Owner notifies the successful Contractor that its Offer has been accepted the Owner will send the Bidder the Contract Form incorporating all agreements between the parties.

23.2 Within seven (7) days of the Notification of the Award the successful Bidder shall sign and date the Contract and return it to the Owner. In case the successful Bidder fails to submit the Contract Agreements duly signed within 7 days from the date of issue of L.O.I., no payment will not be released till the contractor submits the Contract Agreement.

23.3 The final Contract Agreements shall be signed within 7 days from the date, firm submits the final Contract Agreements in all respects.

**24) Quantity Variation**

The Owner reserves the right to increase or decrease the Contract value or the quantity of Offer and services specified without any change in the unit price or other terms and conditions during the execution of the Contract depending upon the final route plan/actual execution required. The quantities of individual items may, therefore, vary as per the final route plan and route profile of the line. The payment shall be made on actual basis for the work executed and services rendered. The actual quantities will be worked out sub-works wise by Concerned A.S.E/ Sr. Xen DS. The quantity variation may be to any extent.

**25) Site Visit**

25.1 The Bidder is advised to visit and examine the Site of Works carried out in recent past and its surroundings and obtain for itself on its own responsibility all information that may be necessary for preparing the Offer and entering into a Contract for construction of the Works. The cost of visiting the Site shall be at the Bidder's own expense.

25.2 This offer includes any unspecified minor works like tree cuttings etc. involved therein, if any. The Owner shall not be liable for any payment to the Contractor on this account.

- 25.3 The Bidder and any of its personnel or agents will be granted permission by the Owner to enter upon its premises and lands for the purpose of such visit.
- 26) Handing over Material**
- JE Concerned shall hand over the material to the contractor on and take its handing over receipt from the contractor in all type of works.
- 27) Storage of Material**
- The Contractor firm shall store all the Material/Equipment in the well-maintained Store at his cost. All the services required for maintaining the Stores shall also be at the cost of the Contractor firm. Contractor firm will store and ensure watch & ward of the dismantled material where required till the same is handed over to the official in charge.
- 28. Mobilization Period & Completion Period of Individual Works**
- The time period to start the job is one month including the mobilization period of 10 days from the date of issue of work order/ LOI whichever is earlier. Concerned Sr. XEN in-charge of work will specify the time period for completion of the individual work at the time of issue of Sub-work Order and he will be competent to grant the extra time if any hindrance (like non availability of material/ shutdown/ any dispute regarding ROW etc.) is beyond the reasonable control of the contractor.
- 29 Defects after Taking Over.**
- 29.1 Defects Liability Period.
- The Defects Liability period will be 6 months from the date of handing over of all works against the bad workmanship.
- 29.2 Making good defects.
- The Contractor shall be responsible for making good any defect in or damage to any part of the Works which may appear or occur during the Defects Liability Period and which arises from bad workmanship.
- 29.3 **Notice of Defects**
- If any such defect shall appear or damage occur, the Owner shall forthwith inform the Contractor thereof stating in writing the nature of the defect or damage. The provisions of Clause-33 shall also apply to all renewals carried out by the Contractor to remedy defects and damage, as if the said renewals had been taken over on the date they were completed to the satisfaction of the Owner.
- 29.4 **Extension of Defects Liability Period**
- The Defects Liability Period shall be extended by a period equal to the period during which the Works (or that portion thereof in which the defect or damage to which the Clause applies has appeared or occurred) cannot be used by reason of the defect or damage but not so as (in the case of any further defect or damage to such portion occurring during any such extension), to extend the Defects Liability Period for the Works.
- 29.5 **Failure to Rectify Defects**
- If the Contractor fails to rectify defects within a reasonable time, the Owner may fix a final time for rectifying the defect or damage.

If the Contractor fails to do so, the Owner may: -

- a) Carry out the Work himself or by others at the Contractor's risk and cost.
  - b) The Contractor shall pay to the Owner the cost of the Work carried out in accordance with the Sub Para (a) above, within 15 days of receipt of the notice thereof from the Owner.
- or
- c) If the defects or damage is such that the Owner has been deprived of substantially the whole of the benefit of the Works or a part thereof, he may terminate the Contract in respect of such parts of the Works as cannot be put to the intended use. The Owner shall to the exclusion of any remedy be entitled to recover from the Contractor all sums paid in respect of such parts of the Works together with the cost of dismantling the same, cleaning the Site etc.

29.6 **Contractor will be fully responsible for any damage to Public/ Private Property while executing the work.**

### **30 Variations**

#### **Owner's right to Vary**

The Owner may issue Variation Order to the Contractor at any time before the Works are taken over, instruct the Contractor to alter, amend, omit, add to or otherwise vary any part of the Works. The Contractor shall not vary or alter any of the Works, except in accordance with a Variation Order from the Owner.

### **31 Currency and Rates of Exchange.**

All payments shall be made in Indian Rupees only.

### **32 Material Account**

Proper account of the Plant/ equipment brought at Site and actually erected shall be prepared by the Contractor on completion of the Works and final payments shall be adjusted on the basis of the same.

### **33 Industrial & Labour Laws**

The successful Bidder shall submit a certificate that he has complied with the provisions of Industrial & Labour Laws including PF Act, ESI Act etc., as may be applicable.

**SE/DS City West Circle,  
PSPCL, Ludhiana.**

**SECTION-III**  
**GENERAL TERMS AND CONDITIONS**  
**PART-1Offering & Contract Agreement**

<b>Clause No.</b>	<b>Description</b>	<b>Page No.</b>
1.1	SUBMISSION OF OFFERS	23
1.2	OFFERS TO BE INVALIDATED	24
1.3	INSPECTION OF SITE BY THE CONTRACTORS	24
1.4	SIGNING OF THE OFFERS	24
1.5	EARNEST MONEY	24
1.6	OFFER TO CONFORM TO SPECIFICATIONS	24
1.7	RATES TO INCLUDE EVERY THING NECESSARY	24-25
1.8	POST OFFER MODIFICATIONS	25
1.9	ALL CUTTING/CORRECTONS TO BE INITIALLED	25
1.10	RIGHT TO REJECT ALL OR ANY OFFER	25
1.11	VALIDITY OF OFFERS	25
1.12	SOLVENCY CERTIFICATE	25
1.13	PLANT & EQUIPMENT	25
1.14	SPLITTING OF WORK	25-27
1.15	PATENT RIGHTS	27
1.16	OFFER /CONSTRUCTION DRAWINGS	27
1.17	SIGNING OF CONTRACT	27

**PART-2General Conditions of Contract**

<b>Clause No.</b>	<b>Description</b>	<b>Page No.</b>
2.1	SCOPE OF CONTRACT	28
2.2	SUPLY OF PLANT MATERIAL AND LABOUR	28
2.3	FIRE FIGHTING EQUIPMENT	28
2.4	WATER AND ELECTRICITY	28
2.5	SETTING OUT	28
2.6	WORK TO BE EXECUTED AS PER DRAWIWNGS SPECIFICATIONS ETC.	29
2.7	DRAWINGS & SPECIFICATIONS	29
2.8	SITE FACILITIES BY CONTRACTOR	29
2.9	WORK TO PROCEED UN-INTERRUPTED	29
2.10	NIGHT SHIFTS	29
2.11	CONTRACTOR'S STAFF	29
2.12	PROTECTION OF WORK BY CONTRACTOR	30
2.13	CO-ORDINATION WITH OTHER AGENCIES	30
2.14	ASSIGNMENT OR TRANSFER OF CONTRACT	30
2.15	COMPLIANCE TO REGULATIONS AND BYE LAWS	30
2.16	CONTRACTOR TO REPORT ACCIDENT	30
2.17	REMOVAL OF CONTRACTOR'S PERSONNEL/WORKMEN	30-31
2.18	WORK OPEN TO INSPECTION	31
2.19	NOTICE BEFORE WORK IS COVERED UP	31
2.20	CONTRACTOR LIABLE FOR DAMAGE DONE	31
2.21	CONTRACTOR'S SUPERVISION	31-32
2.22	CONTRACTOR TO SUPPLY, PLANT, LADDERS,	32

	SCAFFOLDING AND SAFETY MEASURES Etc	
2.23	WORK ON SUNDAYS/GAZATTED HOLIDAYS	32
2.24	COMPENSATION UNDER WORKMEN'S COMPENSATION POLICY	33-33
2.25	CANCELLATION OF CONTRACT FOR INSOLVENCY ASSIGNMENTS OR TRANSFER OR SUB LETTING OF CONTRACT	33-34
2.26	CHANGE IN CONSTITUTION OF FIRM AND ADDRESS	34
2.27	TERMINATION OF CONTRACT ON DEATH	34
2.28	SPECIAL POWERS OF DETERMINATION	34

**PART-3 Performance of the Contract & Payments**

<b>Clause No.</b>	<b>Description</b>	<b>Page No.</b>
3.1	SECURITY DEPOSIT	35-36
3.2	ACTION WHEN WHOLE OF SECURITY DEPOSIT IS FORFEITED	36-37
3.3	EXTENSION OF TIME	37
3.4	BLACKLISTING OF FIRM	38
3.5	FORCE MAJEURE	38
3.6	EXTRA ITEMS	38-39
3.7	FACILITIES TO BE PROVIDED	39
3.8	COMPLETION/FINAL CERTIFICATE	39
3.9	ALL COMPENSATION/PENALTY PAYABLE TO BE CONSIDERED REASONABLE	39
3.10	DEDUCTION OF AMOUNTS DUE TO PSPCL	39
3.11	ACTION WHERE NO SPECIFICATIONS	40
3.12	ACTION ON UNSATISFACTORY PROGRESS	40
3.13	DIARY & PROGRESS REPORT	40
3.14	DAMAGED WORKS	40
3.15	PENALTY FOR DELAY	40-41
3.16	ACTION AND COMPENSATION PAYABLE IN CASE OF BAD WORK	41
3.17	PAYMENTS	41-42
3.18	MODE OF PAYMENT	42
3.19	PAYMENT OF FINAL BILL	42
3.20	SIGNING OF RECEIPTS FOR PAYMENTS	42
3.21	ARBITRATION CLAUSE	42-43
3.22	DISMANTLED MATERIALS	43-44
3.23	RECISSION OF CONTRACT	44
3.24	PRIORITIES & LICENCES BY CONTRACTOR	44
3.25	JURISDICTION	44
3.26	NEGOTIATION	44
3.27	INTERPRETATION	44

**PART-4 Fair Wage Clause & Labour Regulations**

<b>Clause No.</b>	<b>Description</b>	<b>Page No.</b>
4.1	FAIR WAGES	45
4.2	CAMPS & CONVENIENCES	45-46
4.3	MONTHLY RETURN REGARDING WAGES	46
4.4	CONTRACTOR'S LABOUR REGULATIONS	46-48
4.5	INTOXICANTS	48
4.6	E.P.F.	48
4.7	CO-ORDINATION WITH OTHER AGENCIES	49

4.8	ASSIGNMENT OR TRANSFER OF CONTRACT	49
4.9	COMPLIANCE TO REGULATIONS AND BY LAWS	49
4.10	GST	49

**SECTION-III/ Part I**  
**TENDERING & CONTRACT AGREEMENT**

**1.1 SUBMISSION OF OFFERS:**

- i. Notwithstanding anything contained to the contrary in the specifications of offers or in subsequent exchange of correspondence these conditions of contract shall be binding on the contractor and any change or variation expressed or implied, however, made in the said conditions shall not be valid or operated unless expressly approved by the competent authority. The contractor shall be deemed to have fully informed himself and to have special knowledge of the provisions of the conditions of contract here in contained.

The instructions must be carefully observed by all contractors. Quotations/ offers not strictly in accordance with these instructions will be liable to be rejected. Failure to comply with any of these instructions or to offer explanation for non-compliance is likely to render effective comparison of the offer as a whole impossible and may lead to rejection of an otherwise apparently lowest offer.

- ii) The offers must be complete in all respects.  
iii) **Offers shall be submitted only online.**  
iv) Conditional Tenders through e mail, telegraphic through telex fax offers, hard copy, offers not on prescribed Forms or offers without earnest money and cost of tender specification in the required shape shall not be accepted.

THREE PART OFFERS: - The Tender shall be submitted /uploaded in three parts i.e Part-I,Part-II & Part III

- i) PART-I: Proof of deposit of EARNEST MONEY or PEMD AND TENDER DOCUMENT COST  
ii) PART-II: TECHNICAL Bid/Commercial Bid  
iii) PART-III: Offered Price Bid.

Any other documents required to be submitted along with the offers as per the specification, shall also be submitted in this part.

Firstly, the Part-I (Earnest Money & PEMD Certificate) **and tender document cost and Processing Fees** shall be opened and if earnest money **and tender document cost and Processing Fees** is found to be as per the requirements of the specification, only then the Part-II ("Technical/Commercial offer") shall be opened. The offers without earnest money shall be out rightly rejected.

After opening Part-II of the bid (Technical/Commercial), the same will be evaluated by PSPCL.

- v) The Part-III of the offers (Price Offer) shall be opened in case of only those Bidders who's Part-I Earnest money and tender document cost & Part Two Technical Bid is found to be in line with PSPCL specifications. Date and Time for opening of Price Bid shall be intimated later on.
- vi) Bids must be accompanied by the bid Earnest Money & tender cost as specified in the bid document. Bids must be uploaded in three parts online on or before scheduled date/ time and will be opened as per schedule, in the presence of representative of the qualifying bidders who choose to attend. If the office happens to be closed on the date of

receipt/opening of bids as specified, the bids will be opened on the next working day at the same time and same venue.

**1.2 OFFERS TO BE INVALIDATED: -**

The offers must be complete in all respects; Conditional, incomplete or not properly sealed offers and offers received (Part-I) late due to any reason whatsoever will be rejected.

**1.3 INSPECTION OF SITE BY THE CONTRACTORS: -**

Contractors should inspect the tentative sites and examine and obtain all information required and satisfy themselves regarding all matters and things before submission of their offer.

**1.4 SIGNING OF THE OFFERS**

Offers shall be signed by the owner or person holding power of attorney by him to do so. Necessary documents in support thereof should be enclosed with offer at the time of submission, failing which offer may not be considered.

**1.5 EARNEST MONEY:**

- 1 The offers shall be required to submit(via e-payment gateway of GePNIC) earnest money @2%subject to a minimum of Rs 5000 and Maximum of Rs 10 Lakhs of estimated tender cost or PEMD of Rs. 2.5 Lac. However valid fresh certificate regarding PEMD for executing labour outsource work issued by the concerned PSPCL DS office during the last six months immediately preceding the due date for tender opening shall be accepted.
- 2 Public Sector undertakings fully owned by the Punjab Government/Central Government/Other State Government shall be exempted from depositing Earnest Money, provided that a certificate of Government Ownership shall be uploaded online.
- 3 Earnest money shall be forfeited in case of withdrawal/modification of an offer within validity period, as required in the NIT/Offer Specification after opening of offer.
- 4 In case; offers not accepted, the earnest money shall be refunded within 30 days of the award of order/contract to the successful contractor or after the expiry of additional/period whichever is later.

**1.6 OFFER TO CONFORM TO SPECIFICATIONS:**

Offer, which proposes any alteration in the work, specified in the Offer Specification, or in time allowed for carrying out the work or which contains any other terms & conditions of any sort will be liable to rejection. The contractors must convey unconditional acceptance of terms and conditions of the PSPCL.

**1.7 RATES TO INCLUDE EVERY THING NECESSARY:**

- a) Prices & rates offered include cost of entire labour component including all components like carriage & hire of T&P/ machinery.
- b) The unit rates offered shall take into account details of construction which are obviously and fairly intended, and which may not have been specifically

referred to in these documents but are essential for the satisfactory completion of work.

- c) Rates offered to Contractor for all items of work shall remain unchanged irrespective of variation to any extent in quantities of any or all items indicated in schedule of quantities & rates.
- d) Prices include all of the applicable taxes except GST. etc.

### **1.8 POST OFFER MODIFICATIONS**

No modification to the offer shall be made by the Bidder after opening of the offers unless specifically requested by PSPCL. The earnest money of any Bidder who modifies his offer after opening, without any specific reference from PSPCL shall be forfeited without any further reference to the Bidder and he shall be liable to further action like suspension of business dealing/blacklisting.

### **1.9 ALL CUTTING/CORRECTONS TO BE INITIALLED**

#### **1.10 RIGHT TO REJECT ALL OR ANY OFFER:**

The PSPCL officer inviting Tenders /Contracting Agency/PSPCL reserves the right to reject any or all the offers/without assigning any reasons. He will not be responsible for and will not pay for expenses or losses that may be incurred by bidder in preparation and submission of the offer.

#### **1.11 VALIDITY OF OFFERS:**

The offers as submitted should be valid for acceptance for a period of at least **120 days** from the date of opening of tender, unless specified otherwise.

#### **1.12 SOLVENCY CERTIFICATE:**

Every Bidder shall produce along with his bid a Bank Solvency certificate from a scheduled bank of value equal to 15% of estimated tender cost issued after 01-04-2025. If he fails to produce such a certificate, his bid shall not be considered.

#### **1.13 PLANT & EQUIPMENT:**

- i) The contractor, shall at his own expense supply all tools, plant & equipment (hereinafter referred to as T&P) required for the execution of the contract other than those listed in offer documents/contract agreement which subject to their availability may be hired from PSPCL to the contractor or issued free for use in the execution of the work, as specified in the offer documents.
- ii) The details of plant, equipment & machinery available with the contractor in working order for deployment on the work shall be submitted relevant information on the capability, financial resources and experience about himself.

#### **1.14 SPLITTING OF WORK:**

The PSPCL reserves the right to split up the work in the scope of this contract among more than one contractor during the progress of work due to emergency or unsatisfactory progress of work of the contractor. (The provision of reserve the right to split the work at the initial stage of award can be incorporated in specific case where relevant, with the approval of the Competent Authority). The PSPCL will not entertain any claim from any contractor as

a result of such splitting up. The PSPCL also reserve the right to exclude /include any items of work from/into scope of the contract during the progress of work due to any reason whatsoever. The Engineer-in-charge reserves, the right to inject labour, T&P and materials at the contractor's cost at any stage of work if the progress do not commensurate with the committed schedule and the contractor will not have any right to object.

In case of natural calamities/emergency like heavy rain, storm, cyclone, flood, earthquake and other natural calamities firm/firms already doing Labour Outsourcing work of restoration of power supply, PSPCL reserves the right to split up the work of restoration of power supply among Other qualified firms of the ongoing Labour Outsource tender enquiry. PSPCL will not entertain any claim from any contractor/firm as a result of such splitting up.

Works upto 20% of the estimated tender cost can be executed by any empanelled contractor, at the already approved **L1 rates**. However AE/AEE concerned should be allowed for issuance of work order to empanelled contractor upto value of Rs 20000(except maintenance works) and allowed ASE/Sr.Xen/DS to issue work orders value of Rs 20000 to Rs 50000( Including Works of Mtc. ranges from Rs 1 to Rs 50000) This approach aims to streamline the process, ensure timely execution of works, and promote greater efficiency in labour outsourcing operations by adopting the following procedures:

**a). Work Order Issuance & Rotation Policy:**

- Work orders at subdivisions/division level shall be issued to empanelled contractors in strict rotation based on the date of empanelment or serial number assigned in the empanelled list.
- The rotation system shall be cyclical, ensuring equal opportunity to all contractors, subject to their availability and performance record.
- Contractors who decline work without justified reasons or fail to mobilize resources within the stipulated time shall be skipped in rotation for the two turns.
- Separate rotation queues may be maintained for AE/AEE level and ASE/Sr. XEN/DS level work orders (as per value range), based on work complexity and classification (e.g. maintenance vs. general labour).

**b) Monitoring and Performance Review:**

A monthly performance review shall be conducted at the Division level by the concerned Sr. XEN/DS. Parameters for performance evaluation shall include:

Timely execution of work,

Quality of workmanship,

**c) . De-empanelment of Non-Performing Contractors:**

Contractors found consistently non-performing, indulging in delays, or involved in misconduct or malpractice may be considered for de-empanelment. Show-cause notice shall be issued for unsatisfactory performance, giving the contractor an opportunity to respond. Upon review of explanation and performance record, de-empanelment may be done with the approval of the concerned Dy C.E/S.E/DS, depending on the severity and frequency of lapses. The de-empanelled contractor may be barred for a minimum of one year from reapplying for empanelment.

**d) . Record Keeping and Reporting:**

A register shall be maintained at each division to track work order issuance, contractor rotation, performance remarks, and any penalties or warnings issued. A quarterly summary of empanelled contractors performance and actions taken may be submitted to the concerned Dy.C.E/S.E/DS for review and further guidance. These modalities are proposed to ensure equitable distribution of work, maintain accountability, and uphold standards in labour outsourcing activities.

- e) Dy. Chief Engineer/Ds under Central Zone may allot work up to Rs. 30 lakhs from already allocated budget to other qualified firms of ongoing labour outsourcing tender enquiries in all circles under Central Zone who give consent to work at already approved L-1 rates and same terms and conditions of the ongoing tender enquiry of the concerned division.

Re-allocation of work as mentioned in above clause will be done with the approval of CE/DS Central Zone, Ludhiana.

**NOTE: PSPCL reserves the right to split up the work in the scope of this contract among more than one contractor during the progress of work. PSPCL will not entertain any claim from any contractor as a result of such splitting up**

**1.15 PATENT RIGHTS:**

The Bidder shall fully indemnify PSPCL or the officer-in-charge against any action, claim or proceeding relating to infringement or the use of any patent or design or any alleged patent or design rights and shall pay any royalties which may be payable in respects of any article / or part thereof included in the contract.

In the event of any claim being made or action brought against PSPCL Officer-in-charge in respect of the matters aforesaid the contractor shall immediately be notified thereof for taking necessary action provided that payment of indemnity shall not apply when such infringement has taken place in complying with the specific directions issued by PSPCL but the contractor shall pay any royalties payable in respect of any such use.

**1.16 OFFER /CONSTRUCTION DRAWINGS:**

The list of drawings given in the offer documents are intended only to convey to the contractor a general idea of the type & extent of work involved. As such they are indicative for the offer purposes only. The construction drawings shall be issued to the contractor progressively after award of contract to suit work/project priorities. The construction designs can also be revised due to any reason whatsoever before execution of that part of the work. No claim will be entertained from the contractor for any such revision if the construction drawings are at variance from those issued for offer purposes and also due to any revision of the construction drawings issued before execution of that part of the work.

**1.17 SIGNING OF CONTRACT:**

In the event of offer being accepted an intimation shall be given to the contractor, who shall thereupon attend office of Accepting Officer to sign copies of the Specification and other documents and to execute the contract agreement within specified dates of the issue of such intimation failing which acceptance of his offer shall be cancelled and his earnest money will be forfeited.

**SECTION-III / Part -II**  
**GENERAL CONDITIONS OF CONTRACT**

**2.1 SCOPE OF CONTRACT:**

Scope of the contract is to get the work done at labour rates on the guidelines of PSPCL/SLR schedule rates. Entire material will be supplied from the PSPCL stores. The work will be carried out in accordance with the stipulations laid down in the contract and additional drawings as may be provided by the Engineer-in-charge during execution of the works.

**2.2 SUPPLY OF PLANT MATERIAL AND LABOUR:**

Except where otherwise specified the contractor shall at his own expenses supply and provide all labour (including the supervision thereof) transport to or from the site (covered in schedule only) and in and about the works and other things of every kind required for the construction/ erection, completion and maintenance of works.

**2.3 FIRE FIGHTING EQUIPMENT:**

Contractor firm shall provide and maintain adequate portable firefighting equipment at the site during the performance of the contract to the satisfaction of the Engineer-in-charge and the local firefighting authority. The work shall be executed in such a manner so as to minimize fire hazards.

**2.4 WATER AND ELECTRICITY**

Contractor shall make his own electricity and water supply arrangement for construction as well as drinking purposes by installing tube wells, jet pumps etc. and laying distribution pipes wherever required. No arrangement will be made by the PSPCL for water supply.

**2.5 SETTING OUT:**

- a) Contractor shall set out the works and shall be responsible for the true and perfect setting out of the same and for the correctness of the positions, levels, dimensions and alignment of all parts thereof. If at any time any error shall appear during the progress of any part of the work, the Contractor shall at his own cost rectify such error to the satisfaction of the Engineer.
- b) Contractor shall provide all facilities, instruments, and attendance to Sr. Executive Engineer or his deputed representative to check his work. Instruments brought by contractor shall be in good working conditions recently celebrated and are subject to approval by Sr. Executive Engineer. Checking in part or full of any setting out of any line or level by the Engineer shall not in any way relieve Contractor of his responsibility for the correctness thereof.
- c) Contractor shall establish and maintain base lines and bench marks adjacent to the various section of work. All such marks and stakes must be carefully preserved by Contractor and in case of their destruction/dislocation by him, or any of his employees of otherwise, will be replaced at Contractor's expenses.

## **2.6 WORK TO BE EXECUTED AS PER DRAWINGS SPECIFICATIONS ETC:**

The contractor shall execute the work strictly in accordance with the drawings & specifications. The Contractor shall also confirm exactly and faithfully to the designs, drawings and instructions in writing relating to the work as signed by the Engineer lodged in his office and/or supplied to the Contractor.

## **2.7 DRAWINGS & SPECIFICATIONS:**

- a) One set of the Drawings & Specifications and schedule of quantities shall be furnished by Engineer to Contractor. Such copies shall be kept on the works and Engineer and his representatives shall at all reasonable times have access to the same. They shall be returned to the Engineer by Contractor along with the final bill of the Contract.
- b) Matter shown either on the drawings or in the specifications shall be executed/ furnished as if shown in both except where specific provision is made in the drawings superseding the specifications.

## **2.8 SITE FACILITIES BY CONTRACTOR:**

The contractor will be required to provide at his own cost all facilities for his office, warehouse, tool room, change-room, labour huts or any other building-structure required to execute his work.

## **2.9 WORK TO PROCEED UN-INTERRUPTED:**

It shall be ensured by the contractor that work shall proceed un-interrupted even in the event of power failures. As such the contractor should install diesel, generator for adequate capacity or provide adequate number of diesel-operated machinery such as dewatering pumps, concrete mixers, diesel generator, vibrators, welding sets etc.

## **2.10 NIGHT SHIFTS**

The time of completion shall be deemed to exclude working during night shifts. However, Engineer may consider granting permission for working during night shifts if considered essential to complete the work in the stipulated time, on a specific request by a contractor. Night work shall not entitle the contractor to any extra payment. Where night work is in progress, sufficient lights shall be provided by the contractor at his cost to safeguard the workmen and the public and suitable precautions shall be taken to prevent accidents. Excavated areas and under-ground open structures shall be properly barricaded and shall be provided with red lights to prevent accidental falls.

## **2.11 CONTRACTORS'S STAFF**

Bidder shall have qualified engineers and foremen/supervisors with adequate experience in execution of works at the site for satisfactory progress and completion of the work as directed by Engineer. His site Engineer shall be responsible for all aspects of the work at the site and shall take instructions from the Engineer and carry out his instructions. All temporary electrical installations shall be supervised by a qualified electrical supervisor of the contractor.

**2.12 PROTECTION OF WORK BY CONTRACTOR:**

During inclement weather or rain, contractor shall suspend concreting for such time as the Engineer may direct and shall protect from damage all works already in progress or completed just then. All such temporary protective measures shall be at contractor's cost and the contractor at his own expenses shall make any damage to works good to the satisfaction of the Engineer.

Should the work be suspended by reason of strikes/riot by contractor's own employees or any other cause whatsoever except the pre-majeure conditions contractor shall take all precautions necessary for protection of works and make good at his own expense any damage arising from any of these causes.

**2.13 CO-ORDINATION WITH OTHER AGENCIES:**

During the course of contractors' work, other works either by the PSPCL or by other contractors or by both simultaneously will be in progress with in the project area. Contractor is to make his best effort to work in harmony with others in the best overall interest of the project and its speedy construction and comply with engineer's instructions in making alternative arrangements at any time for maintaining the work scheduled at no extra cost to PSPCL.

**2.14 ASSIGNMENT OR TRANSFER OF CONTRACT:**

The contractor shall not assign or transfer the contract or any part thereof, of any share, or interest therein to any other person.

**2.15 COMPLIANCE TO REGULATIONS AND BYE LAWS:**

The Contractor shall conform to the provision of any statute relating to the work and regulations and bye-laws of any local authority and of any Central/State department or Undertakings with whose system the work is prepared to be connected. He shall before making any variation from the drawings or the specifications that may be necessitated for such connections, give the Engineer-in-charge notice, specifying the variation proposed to be made and reasons therefore and shall not carry out any such variation until he has received instructions from the Engineer-in-charge in respect thereof, the contractor shall be bound to give notice required by statute Regulations or Bye-laws as aforesaid and to pay all fees and taxes payable to any authority in respect thereof.

**2.16 CONTRACTOR TO REPORT ACCIDENT**

In the event of occurrence of any accident at or near the site of work or in connection with execution of the work, report shall be made immediately by the contractor to the Engineer, giving full details of the accident. He shall also report such accident to all the competent authorities.

**2.17 REMOVAL OF CONTRACTOR'S PERSONNEL/WORKMEN:**

The contractor shall employ on the execution of the works only such person as are skilled and experienced in their respective trades. The Engineer shall have full power at all times to object the employment of any workmen, foreman or other employee on the work by the contractor and if the contractor shall receive notice in writing from the Engineer requesting the removal of any such men or man from the work, contractor is to comply with the request forthwith. NO such workman, foreman or other employee after his removal from

the work by request of the Engineer shall be re-employed or re-instated on the work by the contractor at any time except with the prior approval in writing of the Engineer. The contractor shall not be entitled to demand the reasons from the Engineer for requesting the removal of any such workman, foreman or other employee.

## **2.18 WORK OPEN TO INSPECTION**

All works under or in course of execution of executed in pursuance of the contract shall at all-time be open to the inspection and supervision of the any agency of the PSPCL Engineer-in-charge/ representative of Engineer and his subordinates and the contractor shall at all times during the usual working hours and all other times at which reasonable notice of the intention of the Engineer or his subordinate to visit the works shall have been given to the Contractor during which period either he could be present to receive order and instructions or have a responsible agent duly accredited in writing present for that purpose. Orders given to the Contractor's duly authorized agents shall be considered to have same force and effect as if they had been given to the contractor himself.

## **2.19 NOTICE BEFORE WORK IS COVERED UP:**

The Contractor shall give not less than 7 days' notice in writing to the Sr. Executive Engineer or his subordinate in-charge of the work before covering up or otherwise placing beyond the reach of measurement any work in order that the same may be measured and correct dimensions thereof taken before the same is so covered up or placed beyond the reach of measurement any work with the consent in writing of Sr. Executive Engineer or his subordinate in charge of the work and if any work shall be covered up or placed beyond the reach of the measurement without such notice having been given or consent obtained the same shall be uncovered at the contractor's expenses, or in default thereof no payment or allowance shall be made for such work or for the materials with which the same was executed.

## **2.20 CONTRACTOR LIABLE FOR DAMAGE DONE:**

If the contractor or his work people or servants shall break, deface injure or destroy any part of a building if they may be working on any building, road, fence, enclosures or grass land or cultivated ground contiguous to the premises on which the work or any part of it is being executed, or if any damage shall happens to the work, while in progress, from any cause whatsoever, the contractor shall make the same good at his own expense, or in default, the Engineer may cause the same to be made good by other workman and deduct the expenses for which the certificate of the Engineer shall be final from any sums that may be at any time thereafter may become, due to the contractor, or from his security deposit or the proceeds of sale thereof, or of a sufficient portion thereof.

## **2.21 CONTRACTOR'S SUPERVISION:**

The contractor shall either himself supervise the execution of the work or shall appoint at his own expense an Engineer as his accredited agent approved by the Engineer In charge, if the contractor does not himself have sufficient knowledge or experience to be capable of receiving instructions or cannot give his full attention to the works. The Contractor or his agent shall be present at the site(s) and shall superintend the execution of the work or works with such additional assistance in each trade, as the work involved shall require and considered reasonable by the Engineer In charge. Directions/instructions given by

Engineer/In charge to the Contractor's agent shall be considered to have the same force as if these had been given to the contractor himself.

If the contractor fails to appoint a suitable agent as directed by the Engineer In charge, the Engineer In charge shall have full powers to suspend the execution of works until such date as suitable agent is appointed by the contractor and takes over the supervision of the work. For any such suspension, the contractor shall be held responsible for delay caused to the works.

## **2.22 CONTRACTOR TO SUPPLY, PLANT, LADDERS, SCAFFOLDING AND SAFETY MEASURES ETC:**

The contractor shall supply at his own cost all materials except such special materials, if any, as may be supplied from the PSPCL's stores in accordance with the contract, plants tools, appliances, implements, ladders, cordage, tackle fuels, lubricants, gases, scaffolding and any temporary works etc. which may be required for the proper execution of the work in the original, altered or substituted and whether included in the specification or other documents forming part of the contract or referred in these conditions or not and which may be necessary for the purpose of satisfying or complying with the requirements of the Sr. Executive Engineer as to any matter on which under these conditions he is entitled to be satisfied or which he is entitled to require together with carriage thereof to or from the work. The contractor shall also supply the requisite number of persons with means and materials necessary for the purpose of setting out works and counting, weighing and assisting in the measurement at any time and from time to time of the work or materials. Failing this the same may be provided by the Engineer at the expenses of the contractor and the expenses may be deducted from any money due to the contractor under the contract or from his security deposit or the proceeds of sale thereof or sufficient portion thereof. The contractor shall take all necessary precautions required to protect the public from accident and shall also be bound to bear expenses of defense of every suit, action or other legal proceeding at Law that may be brought by any person for injury sustained owing to neglect of the above precautions and to pay any damages and costs which may be awarded in any such suit, action or proceedings to any such person or, which may with the consent of the contractor be paid in compromising any claim by any such person.

## **2.23 WORK ON SUNDAYS/GAZETTED HOLIDAYS:**

As most of the work has to be carried out in the planned shutdowns and work permits so it will be required to carry out some work on Sundays and holidays and in odd hours especially in crowded markets/ busy roads but the sanction in writing of the Sr. Executive Engineer will be required. Nothing extra will be payable on a/c of working on Sundays and Gazetted holidays/ night shifts etc.

## **2.24 COMPENSATION UNDER WORKMEN'S COMPENSATION POLICY:-**

In case of fatal/non-fatal accident occurring due to electrocution on PSPCL's network for the negligence on the part of PSPCL, compensation to workmen shall be payable as per Policy issued vide Dy.Secy/ Industrial Relations, Patiala Office Order no. 10/IRO-676 dated 08-12-2023, read with Manager Industrial Relations, Patiala memo number 10136/10495 dated 13.09.2024 with upto date amendments (w.r.t. workers hired through Contractors/Outsourced Agencies). ANNEXUR –J.

The contractor is required to enroll all the deployed workers covered for contract period in the mandatory group insurance scheme of minimum Rs.10 Lacs per worker from its own cost against disablement/death and medical treatment in case of accident. Comprehensive Insurance Policy

shall cover Temporary Disability/Permanent Disability/ Death. Contractor shall quote price accordingly. Group Insurance for Rs 10 lacs may be kept in view while quoting prices.

**2.25 CANCELLATION OF CONTRACT FOR INSOLVENCY ASSIGNMENTS OR TRANSFER OR SUB LETTING OF CONTRACT:**

The Accepting officer, without prejudice to any other right or remedy, which shall accrue thereafter to PSPCL, shall cancel the contract in any of the following case:

- a) Being an individual or if a firm any partner thereof shall at any time be adjudged bankrupt or have a receiving order or order for administration of his Estate made against him or shall take any proceedings for liquidation or composition under any Bankruptcy Act for the time being in force or make any conveyance or assignment of his effect of composition or arrangement for the benefit of his creditor or purport to do so, or if any application be made any Bankruptcy Act for the time being in force the sequestration of his Estate or if a trust deed be granted by him on behalf of his creditors:

OR

- b) Being a Company, shall pass a resolution or the court shall make an order of the liquidation of its affairs, or a Receiver or Manager on behalf of the debenture holders shall be appointed or circumstances shall arise which entitle the court or debenture holders to appoint a Receiver or Manager.

OR

- c) Make an arrangement with or assignment in favour of his creditors, or agree to carry out the contract under a Committee of inspection or his creditors:

OR

- d) Suffers an execution being levied or his good works or property and allows it to be continued for a period of 21 days.

OR

- e) Assign, transfer, Sublet or attempts to assign, transfer or sublet any portion of the work.

Whenever the Accepting Officer exercises his authority to cancel the Contract under this condition, he may complete the work by any means at Contractor's risk and expense provided always that in the event of the cost of completion (as certified by Engineer-in-Charge which is final and conclusive) being less than the contract cost, the advantage shall accrue to the PSPCL and that if the cost of completion exceeds the money due to the Contractor under the contract, the contractor shall either pay the excess amount ordered by the Engineer-in-charge or the same shall be recovered from the contractor by other means. Engineer-in-charge will have powers to take possession of the site and any materials, constructional plant, implements, stores, etc. thereon and or carry out the work by any means at the risk and cost of the contract.

In case the PSPCL completes the work under the provisions of this condition, the cost of such completion to be taken into account in determining the excess cost to be charged to the contractor under this condition shall consist of the cost of materials purchased and/or labour provided by the PSPCL with an addition of such percentage to cover the superintendent and establishment charges as may be decided by the Engineer-in-charge whose decision shall be final and conclusive.

If the contractor fails to pay the excess sum within a period of 30 days the Engineer-in-charge shall have the right to sell any or all of the contractor's unused materials,

constructional plant, implements, temporary buildings etc. and apply the proceeds of the sale thereof towards the satisfaction of any sum due from the contractor under the contract and if thereafter be any balance outstanding from the contractor it shall be recovered in accordance with the provisions of the contract or by other means available.

The contractor shall have no claim to compensation for any loss sustained by him by reason of his having purchased or procured any materials or entered into any commitments or made any advances on account of or with a view to the execution of the works or the performance of the contract and contractor shall not be entitled to recover or be paid any sum for any work actually performed under the contract, unless and until the Engineer- shall have certified the performance of such work and the value payable in respect thereof and the contractor shall only be entitled to be paid the value so certified after adjusting the amount due from him.

#### **2.26 CHANGE IN CONSTITUTION OF FIRM AND ADDRESS:**

In case of offer by partners any change in the constitution of the firm shall be forthwith, notified by the contractor to the Engineer for his information. Any change in the address of the contractor shall also be intimated to the Engineer forthwith.

#### **2.27 TERMINATION OF CONTRACT ON DEATH:**

Without prejudice to any of the rights or remedies under this contract of the contractor dies, the Accepting Officer shall have the option of terminating the contract without compensation to the contractor.

#### **2.28 SPECIAL POWERS OF DETERMINATION:**

If at any time after the acceptance of the offer, PSPCL shall for any reason what so ever not required the whole or any part of the work, to be carried out, the Engineer shall give notice in writing to the fact to the Contractor who shall have no claim to any payment of compensation or otherwise howsoever on account of any profit or advantage which he might have derived from the execution of the work in full but which he did not derive in consequences of the foreclosing of the work. He shall be paid at contract rates, for the full amount of the work executed including such additional works, e.g. clearing of site etc. as may be rendered necessary by the said foreclosing. He shall also be allowed a reasonable payment (as decided by the Accepting officer) for any expenses sustained on account of labour and materials collected but which could not be utilized on the work, as verified by the Engineer-in-charge. The contractor shall not have any claim for compensation on account of any alterations having been made in the original specifications, drawing, designs, and instructions, involving any curtailment of the work as originally contemplated.

### SECTION –III/Part-III

#### **PERFORMANCE OF THE CONTRACT & PAYMENTS**

##### 3.1 SECURITY DEPOSIT

i) The Earnest Money deposited at the time of tender submission shall be converted into Security Deposit. The Security Deposit will be deducted from all the bills at the rate of 5% of the gross value of the work done from time to time after taking into account the EMD converted as security or the successful bidder may submit the additional /complete security deposit @ 5 % of total contract value in the form of BG (issued from SFMS compliant bank/DD/Digital mode of payment within 30 days from the award of contract.

In case a firm deposits complete security deposit in the form of BG, its EMD shall be refunded on submission of BG.

No interest shall be payable to the contractors on the amount of security deposit. PEMD shall not be converted into Security Deposit

ii) Turn-key Projects: For Turn-key projects such as design, manufacture, testing, laying, erection & commissioning and for repair works, the successful Tenderers/contractor shall be required to submit Security deposit for faithful execution of the Contract at the rate of Ten percent {10%} of contract value rounded off to a multiple of Rs. 10/- on the higher side in the form of Bank Guarantee( issued from SFMS compliant bank)/ Demand Draft/ digital mode of payment within 30 days from the award of contract.

Note: For Central/state or any other sponsored schemes the security deposit shall remain as per the Standard Bidding Document only.

iii) The Tenderers having PEMD with PSPCL and hence exempted from depositing Earnest Money with Tenders, shall be required to submit security Deposit @5% or 10% of contract value applicable as per (i) or (ii) above resp. in the form of Bank Guarantee (issued from SFMS compliant bank)/ Demand Draft/ digital mode of payment within 30 days from the award of contract. or The Security Deposit will be deducted from all the bills at the rate of 5% or 10% of contract value applicable as per (i) or (ii) above of the gross value of the work done from time to time.

Note:- The Bank Guarantee (issued from SFMS compliant bank) received by all offices of PSPCL from contractors/firms/vendors etc beconfirmed/verified as per Instructions issued by the O/O Financial Advisor, PSPCL, Patiala office memo no. 84L/1L40 dated 28.7.2023.

iv) The following shall be exempted from depositing security against purchase orders/contracts given to them :-

a, Public Sector undertakings owned by Pb. govt./central Govt./other State govt. supplying material directly through units owned by them subject to submission of documentary evidence of Government ownership, Exemption shall not be applicable if the Tender is submitted for supply of material through private unit/manufacturer.

a. Suppliers/ Executors of Proprietary items or works.

## **B) REFUND OF SECURITY DEPOSIT**

- i) On faithful execution of contract in all respect the security deposit of the contractor shall be refunded after the expiry of warranty/defect liability period as provided in the contract. In case of civil works minimum period of 6 months will be provided as defect liability period in the contract. In case of labour contracts or other similar kind of jobs wherein defect liability period has not been defined in the contract, the defect liability period will be considered as one month after clearing of all dues/liability with the approval of concerned HOD,
- ii) Engineer-in-charge (AE/AEE up to Rs. 10 Lacs of the contract value and Addl SE/Sr. Xen for works costing more than Rs.10 Lacs) shall issue the certificate for site clearance.
- iii) For capital works provisional completion certificate shall be issued within 30 days of the completion of the work. A copy of the certificate shall be sent to Technical Audit Organization. On receipt of the report from Technical Audit after making recovery/rectification of the defects pointed out, construction Organization will Issue final completion certificate.
- iv) On receipt of provisional completion certificate technical audit shall be carried out within defect liability period.
- v) Defect liability period shall commence from the date of completion of work.

### **3.2 ACTION WHEN WHOLE OF SECURITY DEPOSIT IS FORFEITED:**

- a) In any case in which under any clause or clauses of the contract, the contractor shall have rendered himself liable to pay compensation amounting to whole of his security deposit (whether paid in lump-sum or deducted by installment or in case of abandonment of the work owing to serious illness or death of contractor or any other cause, the engineer-in-charge on behalf of the PSPCL shall have power to adopt any of the following courses as he may deem best suited to the interest of the PSPCL:
  - i) To rescind the contract (of which rescission notice of 15 days in writing to the contractor under the signature of Engineer-in-charge shall be conclusive evidence) and in that case the security deposit of contractor shall stand forfeited and be absolutely at the disposal of the PSPCL.
  - ii) The employ labour paid by the PSPCL, to supply materials to carry out the works, or any part of the works debiting the contractor with the cost of labour and the price of the material (as to the correctness of which cost and price, the certificate of the Sr. Executive Engineer shall be final and conclusive against the contractor) and crediting him with value of the work done, in all respects in the same manner and at the same rates as if it had been carried out by the contractor under the terms of the contract and in that case the certificate of Sr. Executive Engineer as to the value of the work done shall be final and conclusive against the contractor.
  - iii) (a)- To order that the work of the contractor be measured up and to take such part thereof as shall be unexecuted out of his hands and to give it to another contractor to complete in which case any expenses which may be incurred in excess of the sums which would have been paid to the original contractor if the whole work had been executed by him (as to the amount of which excess expenses, the certificate in writing of the Sr. Executive Engineer shall be final conclusive) shall be borne and shall be paid by the original contractor and shall be deducted from any money due to him by the PSPCL under the contract or otherwise or from his security deposit or the sale proceeds thereof or a sufficient part thereof.

In the event of the above course being adopted by the Engineer-in-charge the contractor shall have no claim to compensation for any loss sustained by him by reasons of his having purchased or procured any materials or entered into any engagements, made any advance on account of or with a view to the execution of the

work or the performance of the contract. And in case the contract shall be rescinded under the provision aforesaid the contractor shall not be entitled to recover or be paid any sum for any works thereof actually performed by him under the contract unless and until Sr. Executive Engineer have certified in writing performance of such work and the amount payable to him in respect thereof and he only be entitled to be paid the amount as certified.

- b) In any case in which the power conferred by clause referred to above, shall have become exercise able and the same shall not be exercised, the non-exercise thereof shall not constitute a waiver of any of the conditions thereof and such powers shall be exercisable in the event of any future case of default by of the contractor when he is declared liable to pay compensation amounting to the whole of his security deposit and the liability of the contractor for past and future compensation shall remain unaffected.

In the event of the person conferred the power by clause referred to above putting in force by any of the alternatives (i) to (iii) above vested in him under the preceding clause, he may, if he so desires, take possession of all or any tools plant, materials & stores, in or upon the work or the site thereof belonging to the contractor or procured by him and intended to be used for the execution of the work or any part thereof, paying or allowing for the same in account at contract rates or in case of these not being applicable at current market rates to be certified by the Sr. Executive Engineer whose certificate thereof shall be final and conclusive otherwise the Sr .Executive Engineer may by notice in writing to the contractor or any of his authorized agent require him to remove such tools, plants, materials or stores from the premises (within a time is to be specified in such notice) and in the event of the contractor failing to comply with any such requisitions, Sr. Executive Engineer may remove them at the contractor's expense or sell them by auction or private sale on account of the contractor and at his risk in all respects and the certificate of the Sr. Executive Engineer as to the expense of any such removal and the amount of the proceeds and expense of any sale shall be final and conclusive against the contractor

**FORFEITURE OF SECURITY DEPOSIT:** In the event of default on the part of Contractor in the faithful execution, the security deposit shall be forfeited by an order of the Contracting Agency under intimation to other SEs/CEs and other agencies of PSPCL. In the case of field SR XEN's an order of forfeiture of Security Deposit shall be issued by them provided they are Contracting Agency ;under intimation to their SEs, who in turn shall circulate the same to other SEs, CEs and other agencies of PSPCL.

The forfeiture of Security deposit shall be without prejudice to any other rights arising or accruing to the PSPCL under relevant provisions of the contract like penalty/damages for delay in delivery or risk execution of work including suspension of business dealings with PSPCL for a specific period.

### **3.3 EXTENSION OF TIME**

If the contractor shall desire an extension of the time limit for completion of the work on the ground of his having been unavoidably hindered in execution or of any other ground, he shall apply in writing to the Dy CE/SE DS and the Dy CE/SE DS may if in his opinion there are reasonable grounds for granting extension, allow such extension as he thinks necessary or proper. The decision of the Engineer-in-charge in this regard shall be final and binding. For any delay in work on account of act of omission or commission at the part of PSPCL viz. delay in issue of material, alterations, omission, additions, substitutions in

original specifications, drawings, design etc. only extension of time will be agreed for the period so lost and no compensation would be given on this account.

### **3.4 BLACKLISTING OF FIRMS**

The authority next higher to the competent authority shall decide the question of blacklisting any firm or debarring any firm from business dealings. For instance, for cases decided by CPC/PPC/Purchase Committee (General), the competency to blacklist the firm lies with the WTDs. However, for cases decided by WTDs the competency to blacklist the firm shall be with the WTDs only.

### **3.5 FORCE MAJEURE:**

If at any time during the continuance of the work the performance in whole or in part by either party of any obligation under this contract, shall be prevented or delayed by reasons of any war, hostility, acts of public enemy, Civil Commotion, sabotage, floods, explosion, epidemics, fires or other acts of God, strikes and lockout (hereinafter referred to as eventualities) then, provided notice of the happening of any such eventuality is given by either party to the other within 15 days from the date of occurrence thereof, neither party shall be reasons of such eventuality be entitled to terminate this contract nor shall either party have any claim for damages against the other in respect of such nonperformance or delay in performance and construction of work under this contract shall be resumed as soon as practicable after such eventuality has ceased. Appropriate extension in time of completion shall be granted.

### **3.6 EXTRA ITEMS**

- a) Extra items of work shall not vitiate the contract. The contractor shall be bound to execute extra items of work as directed by Engineer-in-charge. If extra items due to any alterations, addition or substitution or due to any other cause include any class of work for which no rate is specified in the contract, the rates for such item/items shall be worked out on the basis of Common Schedule of Rates and approved by the competent authority. Where the rates for non-agreement items do not exist in the Common Schedule of Rates, the same shall be determined by analysis.
- b) In case of contract, not based on the Common Schedule of Rates, the rates for such items shall be worked out as follows:
  - i) Cost of labour shall be calculated on the basis of the actual labour employed (excluding supervisory staff) as recorded at site for the item of work to the entire satisfaction of the Nodal officer whose decision shall be final and binding.
- c) The Sr. Executive Engineer can sanction the rate provided the total amount of all such items under one contract is within his competence to accord technical sanction. When the total amount of all such items under one contract exceeds financial limit of the Sr. Executive Engineer, he shall refer the matter to the SE who will sanction the rate, if the total amount of all such items including those already sanctioned by the Sr. Executive Engineer is within his power to accord technical sanction, otherwise the matter will be referred to the EIC/DS, Central Zone who has full powers to sanction such rates.

The Contractor shall deliver in the office of the Sr. Executive Engineer on or before the 10<sup>th</sup> of every month during the continuance of work covered by the contract, return showing details of any work claimed for as extra and as such return shall also contain the value of such work as claimed by the contractor for which value

shall be based on the guidelines given above. Extra items shall be taken in hand only after written order from Engineer-in-charge. The contractor shall include in such monthly return particulars of all claims of whatsoever kind and, howsoever arising, which at the date thereof he has or may claim to have against the PSPCLs under or in respect of or in any manner arising out of the execution of the work and the contractor shall be deemed to have waived all claims not included in such return and will have no right to enforce any such claims not so included, whatsoever be the circumstances.

### **3.7 FACILITIES TO BE PROVIDED**

#### **A) WATER & ELECTRICITY FOR CONSTRUCTION OF WORK & CONTRACTOR STORES/OFFICE:**

Refer Para 2.4 of Part-2 of Section-III

### **3.8 COMPLETION/ FINAL CERTIFICATE**

On completion of every sub-work the contractor shall be furnished with completion certificate by the Sr. Executive Engineer of such completion but no such certificate shall be given nor shall the work be considered to be complete until works are taken over and/or duly tested and put to operation as the case may be nor until the work shall have been measured by the Sr. Executive Engineer or where the measurements have been taken by the subordinates until they have received the approval of the Sr. Executive Engineer the said measurement being binding and conclusive against the contractor. If the contractor fails to comply with the requirements of his clause as to removal of scaffolding, surplus material and rubbish and cleaning of dirt on or before the date fixed for the completion of the work, the Sr. Executive Engineer may at the expense of the contractor, remove such scaffolding surplus materials and rubbish and dispose of the same as he thinks fit and clean off such dirt as aforesaid, and the contractor shall forthwith pay the amount of all the expenses so incurred, shall have no claim in respect of any such scaffolding or surplus materials as aforesaid except for any sum actually realized by the sale thereof.

Final completion certificate of the contract will be issued only after the entire sub-works are successfully completed and issued with the individual completion certificates.

### **3.9 ALL COMPENSATION/ PENALTY PAYABLE TO BE CONSIDERED REASONABLE:**

All sums payable by way of compensation/penalty by contractor under any of these conditions shall be considered as reasonable compensation to be applied to the use of PSPCL without reference to the actual loss or damage sustained, and whether or not any damage shall have been sustained.

### **3.10 DEDUCTION OF AMOUNTS DUE TO PSPCL:**

Any excess payment made to the contractor inadvertently or otherwise under this contract or on any account whatsoever and any other sum found to be due to PSPCL by the contractor in respect of the contract or any other contracts or work order or on any account whatsoever may be deducted from any sum whatsoever payable by the PSPCL to the contractor either in respect of this contract or any work order of contractor or on any other account by any other office of the PSPCL.

### **3.11 ACTION WHERE NO SPECIFICATIONS:**

In the case of any class or work for which there is no such specification mentioned in the contract, such work shall be carried out in accordance with specifications as decided by the concerned Design Officer.

### **3.12 ACTION ON UNSATISFACTORY PROGRESS:**

If the progress of a particular portion of the work is unsatisfactory, the Sr. Executive Engineer whose decision shall be final, shall notwithstanding that the general progress of work is satisfactory be entitled to take action under Clause 3.2 I offer after giving the contractor 10 days' notice in writing and the contractor will have no claim for compensation for any loss sustained by him owing to such action.

### **3.13 DIARY & PROGRESS REPORT:**

- a) A daily diary register will be kept at site office. Contractor will supply all detailed information every day at 9.30 hours for the preceding day and the diary will be jointly signed by Sr. Executive Engineer/AEE/AE and contractor's representative every day in token of its correctness. A work instruction Book serially numbered will also be kept at site office and day-to-day instructions will be given in that Book. Contractor's representative shall report every day to see these instructions and sign them at the bottom in token of his having seen them. If the contractor's representative does not actually see the instructions and or sign the same that shall not be in any way relieve him of his obligations or responsibilities.
- b) Contractor shall supply all information regarding procurement of material and progress of construction work, as is required by the Sr. Executive Engineer, for compiling the weekly progress reports. This information shall be supplied at 9.00 hours on every Monday, for the preceding week.

### **3.14 DAMAGED WORKS:**

The contractor will be responsible for any and all losses of materials and damage to works till they are handed over as a result of floods, earthquake, wars, rains, storms and other such acts of God etc. The owner will not be responsible for any compensation as a result of such damage or loss to the contractor and the contractor shall be liable to get right such damage at his own cost to the satisfaction of the Engineer/Owner. The contractor shall arrange insurance against above risks at his cost.

### **3.15 PENALTY FOR DELAY:**

The time allowed for carrying out the work as entered in the contract shall be strictly observed by the contractor and shall be reckoned from the date on which order to commence work is given to the contractor. The work shall throughout the stipulated period of the contract be preceded with all due diligence (time being deemed to be the essence of the contract on the part of the contract) and the contractor shall pay as penalty as under: -  
Penalty equal to one half percent per week subjected to maximum of 10 % of balance work of respective month on the pro-rata cost of balance connections. The penalty shall be calculated in proportionate to the total cost of work order and no of connections allotted and will be imposed on balance connection for respective month. However, after full completion period, the contractor shall pay as penalty equal to an amount of one half percent of actual cost of work order (Standard condition of PSPCL) as shown in contract for every week, if the work

remains unfinished after the contract completion period but the entire amount of penalty to be paid under the provision of this clause shall not exceed 10% of the actual total cost of the work order which will include the estimated cost of the balance work left out. However, the penalty deducted due to noncompliance of monthly progress, the same shall be adjusted during the final computation of penalty. This clause will be made applicable phase wise by considering contract value of each phase separately.

### **3.16 ACTION AND COMPENSATION PAYABLE IN CASE OF BAD WORK:**

If it shall appear to the Engineer-in-Charge or his subordinate in charge of the work, that any work has been executed with unsound imperfect or unskillful workmanship, or with materials of any inferior description or that any materials or articles provided by him for the execution of the work are unsound, or of a quality inferior to that contracted or otherwise not in accordance with the contract, the contractor shall on demand in writing from the Engineer-in-charge specifying the work materials or articles complained of notwithstanding that the same may have been inadvertently passed, certified and paid for forthwith rectify or remove and reconstruct the work as specified in whole or in part as the case may require or as the case may be, remove that materials or articles so specified and provide other proper and suitable materials or articles at his own proper charge and cost, and in the event of his failing to do so within a period to be specified by the Engineer-in-Charge may rectify or remove and re-execute the work or remove and replace with other material or articles complained of as the case may at the risk and expense in all respect of the contractor.

### **3.17 PAYMENTS:**

- a) The contractor shall submit all bills on the printed forms in the office of the concerned Addl.SE/Sr. XEN, and charges in the bills shall always be entered at the rates specified in the Work Order.
- b) A bill shall be submitted by the contractor each month on or before the date fixed by the Addl.SE/Sr. XEN concerned for all works executed in the previous month (or on completion of any sub work) and Addl. SE/Sr. Executive Engineer shall take or cause to be taken the requisite measurement for the purpose of having the same verified and the claim, as far as admissible, adjusted, if possible before the expiry of ten days from the presentation of bill
- c) No payment shall be made for works estimated to cost less than rupees ten thousand, till after the whole of the works shall have been completed and a certificate of the completion given. But in the case of works estimated to cost more than rupees ten thousand the contractor shall on submitting the bill thereof be entitled to receive a monthly payment proportionate to the part thereof when approved and passed by the Engineer-in-charge, whose certificate of such approval and passing of the sum so payable shall be final and conclusive against the Contractor. But all such intermediate payments shall be regarded as payments by way of advance against the final payment only and not as payments for work actually done and complete, and shall not preclude the requiring of bad, unsound and imperfect or unskillful work to be removed and taken away and reconstructed or re-erected or be considered as an admission of the due performance of the contract or any part thereof in any respect, or the accruing of any claim, nor shall it conclude, determine, or affect in any way the powers of the Engineer-in-charge under these conditions, or any of them as to the final settlement and adjustment of the accounts or otherwise, or in/any other way vary or affect the contract. The final bill shall be submitted by the contractor within one month of completion of the work otherwise the ASE/Sr. XENs Certificate of the measurement

and of the total amount payable for the work accordingly shall be final and binding on all parties.

- a) The payment terms shall be regulated as under: -
  - i) Up to 90% payment against Work executed and energized but not handed over/ finally accepted.
  - ii) Balance payment on acceptance/ taking over of the work.
  - iii) The contractor shall indemnify the PSPCL on non-judicial stamp paper against safe custody of the said material and that the same material will be used for execution of work for which the payment has been made.

### **3.18 MODE OF PAYMENT**

- 1 Usual procedure as per PSPCL for payment to the contractor as per PSPCL instruction shall be followed. However, before payment, the measurement of the works executed by the contractor shall be recorded by the JE in charge and checking the same by concerned AEE/AE and counter/ sample checking by Addl.SE/ Sr.XEN concerned for quality assurance. All payments pertaining to these works shall be made by respective DS Divisions.
- 2 Payment to contractor for erected works shall be released only on the basis of measurement of erected works.
- 3 DDO will ensure about registration of firm under Building & Other Construction Workers Act-1996 under Section- 7 and Section 12 before payment of running bill.
- 4 However payment will be made after pre-audit the bills from AO Works/Banking. During execution of work, under un-foreseen circumstances, some dispute may crop up or may need some clarifications on any issue, the same shall be reviewed by the Dy. Chief Engineer/Op., City West Circle Ludhiana and his decision shall be final and binding for all intents and purposes.
- 5 **Any Bank charges levied by the bank will be borne by the contractor.**

### **3.19 PAYMENT OF FINAL BILL:**

After the work is completed, final bill would be paid on the certification of an officer not below the rank of ASE/ Sr.XEN (and of AE/ AEE in case of sub-works) that the work is done according to drawings and specifications attached to the offer and on recording of detailed measurements, if any additions and alterations have carried out, detailed measurements in respect thereof shall be recorded and extra payments or deduction are to be regulated as per item rates offered by the contractor while submitting the offer and if there are any items in the additions and alteration for which the contractor has not offered a rate, the payment shall be regulated as per clause for "extra items".

### **3.20 SIGNING OF RECEIPTS FOR PAYMENTS:**

The PSPCL may refuse or suspend payments on account of a work when execution by a firm or by contractor described in their offer as firm unless receipts are signed by all the partners or one of the partners or some other person who produces written authority enabling him to give effectual receipts on behalf of firm.

### **3.21 ARBITRATION CLAUSE:**

If any question, difference or objection, whatsoever shall arise in any way connected with or arising out of this instrument or the meaning or operation of any part thereof for the rights, duties or liabilities of either party then save in so far as the decision or any such matter is herein before provided and has been so decided every such matter including whether its

decision has been otherwise provide for and/or whether it has been finally decided accordingly, or whether the contract should be terminated or has been rightly terminated and as regards the rights and obligations of the parties as the result of such termination shall be referred, for sole arbitration of the nominee of the PSPCL, who in case of dispute involving an amount exceeding Rs.50,000/- shall give a reasoned award and his decision shall be final and binding and where the matter involves a claim for the payment or recovery or deduction of money, only the amount, if any awarded in such arbitration shall be recoverable in respect of the matter so referred. If the matter is not referred to arbitration within 180 days of the date of completion of work or payment of the final bill whichever is later all the rights and claims under the contract shall be deemed to have been forfeited and absolutely barred.

- a) Upon every or any such reference, the cost of and incidental to the reference and award respectively shall be in discretion of the Sole Arbitrator so appointed who may determine the amount thereof or direct the same to be taxed as between solicitor and client or as between party and party and shall direct by whom and to whom and in what manner the same is to be borne and paid.
- b) The work under the contract shall be continued during the arbitration proceedings and no payment due or payable by the purchaser/PSPCL shall be withheld on account of such proceedings.

### **3.22 DISMANTLED MATERIALS:**

Some of the dismantled materials received from the dismantlement of structures, works, huts etc. shall have to be re-used handed over to the owner & stacked in a manner approved by the Engineer in stores/site without any extra cost to the owner.

### **3.23 RECISION OF CONTRACT:**

- a) Makes default in commencing the work within a reasonable time from the date of issue of work order and continue in that state after a reasonable notice from Engineer-in-charge. In the opinion of the Engineer-in-Charge at any time, whether before or after the date or extended date for completion, make default in proceeding with the work, with due diligence and continue in that state after a notice of seven days from Engineer-in-Charge.
- b) Fails to comply with any of the terms & conditions of the contract or after 7 days' notice in writing with orders properly issued the render. Fails to complete the work, work order and items of work on individual dates for completion and clears the site on or before the date of completion or fails to achieve the progress as set out in the contract.
- c) If contractor commits breach of any terms/conditions envisaged in the contract. Any bribe, gratuity, gift, loan, perquisite, records or advantage, pecuniary or otherwise shall either directly or indirectly be given, promised or offered by the contractor or any of his servants or agents to any public officer, person in the employment of PSPCL in any way relating to his office or if any such officer or person of PSPCL shall become in any way directly or indirectly interested in the contract.
- d) In such case the PSPCL may notwithstanding any previous waiver, alter giving 10 days' notice in writing to contractor, terminate the contract and the security deposit of the contractor shall thereupon stand forfeited and in addition the contractor shall not be entitled to recover or be paid for work theretofore actually performed under the contract and further, PSPCL may enter upon and take possession of the works and all plant, tool, scaffolding, sheds, machinery etc. and materials lying upon premises or the adjoining lands or roads and use the same as his own property or may employ the same by means of his own servants an workmen in carrying on and completing the

works and contractor shall not in any way interrupt or do any act, matter or thing to prevent or hinder such other contractor or other person or persons employed for completing the finishing of using the material and plant for the works, when the work shall be completed or as soon thereafter as convenient, Engineer shall give a notice in writing to contractor to remove his surplus materials and plant and should fails to do so within a period of 14 days from issue of the notice by him, PSPCL may sell the same by public auction. The amount so realized shall be adjusted against any money due to the PSPCL by the contractor.

- e) In case the PSPCL intends to foreclose the contract before the completion of the job due to any reason then the Engineer-in-charge shall serve 30 days clear notice to the contractor. The work completed up to date of issue of the notice shall be measured jointly, un-utilized materials supplied by the PSPCL shall be returned to the store at issue rate including storage charges. The contractor shall be compensated for un-utilized material procured by him on the original rate of purchase duly supported by the bills or the market prevailing rate whichever is more. No compensation will be payable for the material/T&P brought to site after the issue of the notice. The contractor shall not be entitled for any other claim whatsoever on this account.
- f) If contractor shall assign or transfer the contract or any part thereof, of any share, or interest therein to any other person.

### **3.24 PRIORITIES & LICENCES BY CONTRACTOR:**

The contractor shall be responsible for making his own arrangement for priorities or licenses, for all materials, which are not to be supplied by the Punjab State Electricity PSPCL. Only recommendatory letters where necessary shall be issued on the specific request by the contractor.

### **3.25 JURISDICTION:**

Jurisdiction for filing any suit in case of any dispute shall be the Courts at Ludhiana, Punjab.

### **3.26 NEGOTIATION:**

No negotiation affecting prizes or basic features of NIT/Specification shall be conducted with contractors after opening of offers except under specific orders of accepting authority after the reasons to be recorded.

### **3.27 INTERPRETATION**

If any time, any question arises relating to the interpretation of these specifications, it shall be referred to the CE/DS Central Zone, PSPCL, Ludhiana whose decision on the point shall be final.

## **SECTION-III/ Part-IV**

### **FAIR WAGE CLAUSES & LABOUR REGULATIONS**

#### **4.1.0 FAIR WAGES:**

- 4.1.1 The contractor shall pay not less than fair wage to labour engaged by him on the work. Fair wage means wage whether for time or piece work notified from time to time for the work and where such wages have not been so notified the wages prescribed by the Punjab Government, PWD/PSPCL for District in which the work is done.
- 4.1.2 The contractor shall not withstand the provisions of any agreement to the contrary, cause to be paid fair wage of labourer's indirectly engaged by him on the work in claiming any labour engaged by his contractor in connection with the said work as if the labourer's had been directly employed by him.
- 4.1.3 In respect of all labour directly or indirectly employed on the works for the performance of the Contractor's part of the agreement the Contractor shall comply with or cause to be complied with the Punjab Govt. Contractor's labour Regulations made by the Government from time to time in regard to payment of wages, wage period, deductions from wage and other terms of employment of inspection and submission of periodical returns and all other matters of like nature.
- 4.1.4 The concerned ASE/Sr. XEN DS Division shall have the right to deduct from the money due to the contractor any sum required or estimated to be required for making good of non-fulfillment of conditions of the Contract from the benefits of the works. Non-payment of wages or decisions made from him or their wages which are not justified by the terms of the Contractors or for observance of the regulations
- 4.1.5 Vis-à-vis Punjab Govt./PSPCL. The Contractor shall be primarily liable for all payments to be made under and for the observance of the regulations without prejudice to his right to claim indemnity for his Sub-Contractor.
- 4.1.6 No labour below the age of 18 years and more than 60 years shall be employed on the work.
- 4.1.7 It will be the responsibility of the Contractor to ensure that trees in the camp site and in the vicinity, there fruit etc. are not damaged by his labour or agent. Cost of such damage, if any, shall be assessed at the discretion of the Sr. Executive Engineer and deducted from the bill of the contractor.

#### **4.2.0 CAMPS & CONVENIENCES:**

- 4.2.1.1 Suitable temporary hutting, accommodation as in the opinion of the concerned Sr. Executive Engineer may be necessary, outside the premises of the PSPCL's land. The Contractor shall not put up any unauthorized canteens or tea shops on PSPCL's property without the knowledge and prior approval of the Sr. Executive Engineer in writing.
- 4.2.2 Trenches, Latrines, bathing enclosures and platform separately for men and women and their regular cleanliness to the satisfaction of the Medical Officer In- charge of the area.

4.2.3 Clean drinking water to be provided by the Contractor.

**4.3.0 MONTHLY RETURN REGARDING WAGES:**

The Contractor shall be required to submit to Labour Welfare Officer/Sr. Executive Engineer, on the tenth of every month a return on the prescribed form for the payment of wages under the fair wage clause. This failure of the Contractor to do so shall be considered as breach of the Contract and will be dealt with as such.

**4.4.0 CONTRACTOR'S LABOUR REGULATIONS:**

4.4.1 **DEFINITIONS:** In these regulations unless otherwise expressly indicated the following works and expressions shall have the meaning hereby assigned to them respectively, that is to say:

- a) Labour means workers as employed by PSPCL/Public Works Department by the Contractor directly or indirectly through a Sub-Contractor/or other person or any agent on his behalf.
- b) 'Contractor' shall include every person whether a Sub-Contractor or headman or agent, employing labour on the work taken on contract.
- c) 'Wage' shall have the same meaning as defined in the payment of wages Act, 1936 and includes time and piecework rate wages.

**4.4.2 DISPLAY OF NOTICES REGARDING WAGES ETC.**

The Contractor shall before the commences his work on contract display and correctly maintain and continue to display and correctly maintain in a clean and legible conditions in conspicuous places on the work notice in English and the local Indian Languages spoken by the majority of the workers, giving the particulars of wages and other alike matter as required under regulations.

**4.4.3 PAYMENT OF WAGES:**

- a) Wages due to every worker shall be paid to him directly.
- b) All wages to be paid in bank account.
- c) The Contractor shall fix the wage periods in respect of which the wages shall be payable.
- d) No wage period shall exceed one month
- e) Wages of every workmen employed on the Contract shall be paid before expiry of the day after the last day of the wage period in respect of which the wages are payable.
- f) When the employment of any worker is terminated by or on behalf of the Contractor, the wages earned by him shall be paid before the expiry of the day succeeding the one on which his employment is terminated.
- g) All payment of wages shall be made on a working day.
- h) Wage register and wage card etc.:  
The Contractor shall maintain a wage register of workers, in such form as may be convenient, but the same shall include the following particulars.
- i) Rate of daily or monthly wages.
- ii) Nature of work on which employed.
- iii) Total amount payable for the work during each wage period.
- iv) Total numbers of days worked during each wage period.

- v) All deductions made from the wages with an indication in each case on the ground for which the deduction is made.
- vi) Wages actually paid for each wage period.
- vii) The Contractor shall also maintain a wage card for each worker employed on the work.
- viii) The authority competent to accept the Contract may grant an exemption from the maintenance of wage register and wage cards, to a Contractor who in his opinion may not directly or indirectly employ more than one hundred persons on the work.

#### 4.4.4 **FINES AND DEDUCTION WHICH MAY BE MADE FROM WAGE:**

The wages of a worker shall be paid to him without any deduction of any kind except the following: -

- a) Fines
- b) Deductions for absence from duty i.e. from the place or places where by the terms of his employment he is required to work. The amount of the deductions shall be in proportion to the period for which he was absent.
- c) Deduction for damages to or loss of goods expressly entrusted to the employed persons for custody or for loss of money for which he is required to account where such damage or loss is directly attributable to his neglect or default.
- d) Any other deduction, which the PSPCL may from time to time allow.
- e) No fines shall be imposed on a worker and no deduction for damage or loss shall be made from his wages until the worker has been given an opportunity of showing causes against such fines or deductions.
- f) The total number of fines, which may be imposed in one wage period on a worker, shall not exceed three percent of the wages payable to him in respect of that wage period.
- g) No fines imposed on any worker shall be recovered from him by installments, or after the expiry of 60 days from the date of which it was imposed.

#### 4.4.5 **REGISTER OF FINES ETC:**

- a) The Contractor shall maintain a register of fines and of all deductions for damages or loss. Such register shall mention the reason for which fine was imposed or deduction for damage or loss was made.
- b) The Contractor shall maintain a list in English, Hindi and in the local Indian Language clearly defining acts and conditions for which penalty or fine can be imposed. He shall display such list and maintain it in a clean and legible condition in conspicuous places on the work.

#### 4.4.6 **PRESERVATION OF REGISTERS:**

The wage register, the wage card and the register of fines, deduction required to be maintained under these regulations shall be preserved for 12 months after the date of last entry made in them.

**4.4.7 POWER OF LABOUR WELFARE OFFICE TO MAKE INVESTIGATION OF ENQUIRY:**

Authority of the Punjab Government in their behalf shall have power to make enquiries with a view of ascertaining and enforcing due and proper observance of the wage clauses and the provision for regulation. He shall investigate into any complaint regarding any fault made by the Contractor or by the Sub-Contractor in regard to such provision.

**4.4.8 REPORT OF LABOUR WELFARE OFFICER:**

The Labour Welfare Officer or any other person authorized aforesaid shall submit a report of the results of investigation or enquiry to the Sr. Executive Engineer concerned indicating the extent if any, to which the fault has been committed and the amount of the recoveries in respect of the cost of commission and omission of the labourer, with a note that necessary deduction from the contractor's bill be made and the wages and other deductions paid to the laborers concerned.

**4.4.9 APPEAL AGAINST THE REMISSION OF LABOUR WELFARE OFFICER:**

Any person aggrieved by the decision and recommendation of the Labour Welfare Officer or their person so authorized may appeal against such decision to the Labour Commissioner but subject to such appeal the decision of the officer shall be final and binding upon the contractor

**4.4.10 INSPECTION OF REGISTERS AND CARDS:**

The Contractor shall allow inspecting of the registers and cards to any of his workers or to his agent at a convenient time and place after due notice is received, or to the Labour Welfare Officer or any other officer authorized by the Punjab Government on its behalf.

**4.4.11 SUBMISSION OF RETURNS:**

The Contractor shall submit periodical returns as may be specified from time to time.

**4.4.12 AMENDMENTS:**

The Punjab Government may from time to time, add to or amend these regulations and on any question so as to effect applications interpretations of these regulations. The decision of the Labour Commissioner to the Punjab Government or any other person authorized by the Punjab Govt. in that behalf shall be final.

**4.5 INTOXICANTS:**

Contractor shall not permit or suffer the introduction or the use of intoxicant upon the works embraced in his contract or upon any of the ground occupied or controlled by him.

**4.6 E.P.F.**

The contractor will submit to PSPCL, the EPF clearance certificate from the Regional Provident Fund Commissioner authorities from time to time. The final bill and security of the contracting agency will be released only after the contracting agency will supply the final clearance for the project from the Regional Provident Fund Commissioner authorities.

**4.7 CO-ORDINATION WITH OTHER AGENCIES:**

During the course of contractor's work, other works either by the PSPCL or by other contractor or by both simultaneously will be in progress with in the project area. Contractor is to make his best effort to work in harmony with others in the best overall interest of the project and its speedy construction and comply with Engineers instructions in making alternative arrangements at any time for maintaining the work scheduled at no extra cost of PSPCL.

**4.8 ASSIGNMENT OR TRANSFER OF CONTRACT;**

The contractor shall not assign or transfer the Contract or any part thereof, any share, or interest there in to any other person.

**4.9 COMPLIANCE TO REGULATIONS AND BY LAWS;**

The contractor shall confirm to the provision of any statute relating to the work and regulations and bye-laws of any local authority and of any Central/State Department or Undertakings with whose system the work is prepared to be connected. He shall, before making any variation from the drawings or the specifications that may be necessitated for such connections, give the Engineer-in-charge notice, specifying the variation proposed to be made and reasons therefore and shall not carry out any such variation until he has received instructions from the Engineer-in charge in respect thereof, the contractor shall be bound to give notice required by Statute Regulations or Bye-laws as aforesaid and to pay all fees and taxes payable to any authority in respect thereof.

**4.10 GST**

The contractor will be fully responsible to pay the GST applicable from time to time. The payment of next RA bill of the contractor shall be processed after receipt of payment of GST of previous labour bill by the contractor to the concerned department.

**SE/DS, City West Circle,  
PSPCL, Ludhiana.**



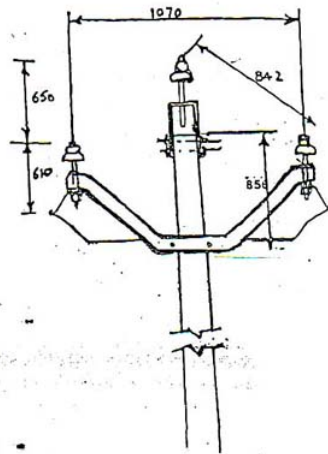

ANGLE $\theta$	A	B	C
30°	750	1500	4125
45°	1100	1300	7150

IIKY IN DELTA FORMATION

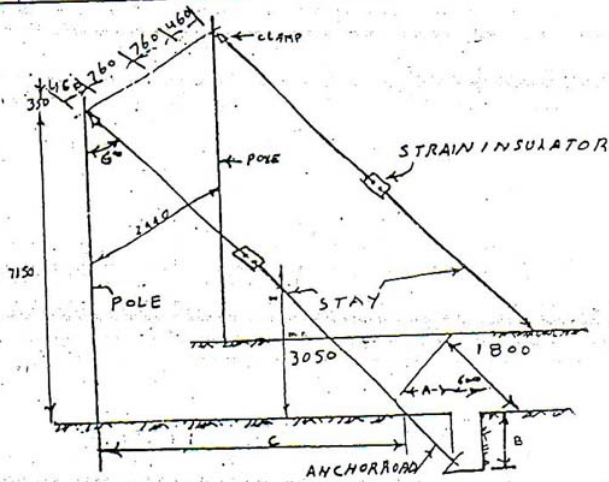

DISTANCES FOR 30° AND 45° ANGLES OF STAY WIRE WITH POLE

- 1) ALL DIMENSIONS ARE FROM CENTRE TO CENTRE
- 2) ALL DIMENSIONS ARE IN MM.

DIRECTOR DS ENGG & U.S. IMP. PAT.	
DRG. NO. DDU-162	SCALE: 1/4" = 1'-0"
<i>Prin</i> D.MAN	<i>Wing</i> A.D.
<i>Hydral</i> D.D.	<i>Arora</i> DIREC

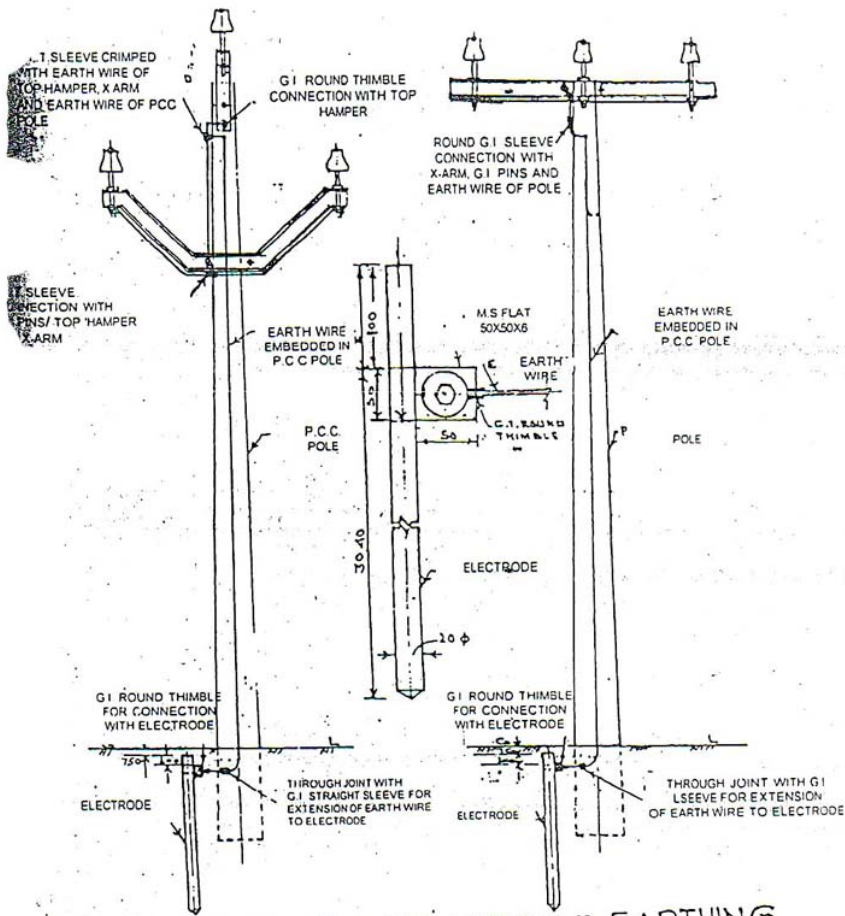

**DETAIL OF ELECTRODE AND POLE EARTHING CONNECTIONS.**

**LIST OF MATERIAL FOR POLE EARTHING WITH SINGLE ELECTRODE**

NO.	DESCRIPTION	QTY.
1	G.I. ROUND THIMBLE	4
2	G.I. T. SLEEVE	2
3	G.I. STRAIGHT SLEEVE	1
4	ELECTRODE	1 NO.
5	G.I. WIRE 4 M.M. Ø	1 KG. APP.

ALL DIMENSIONS ARE IN M.M.

DIRECTOR D.S. ENGG & U.S. IMP PATIALA	
DRG NO DDU-186 SCALE 1:1	
<i>[Signature]</i>	<i>[Signature]</i>
D/MAH	A.D. D.D. DIRECTOR

### Dugging of Pole Holes

The size of the hole is determined by the size of the pole to be erected/set. The hole should be large enough to allow plenty of space on each side of the pole for use of ramming device. The dia of the hole at the top should not be greater than at the bottom, but, rather larger at the bottom to allow shifting of the pole for lining.

Minimum depth of planting of PCC poles in the ground as per IS-1678/1973 is given below:

<u>Length of Poles (metres)</u>	<u>Minimum depth in ground (Metres)</u>
6.0 to 7.0	1.2
7.5 to 9.0	1.5
9.5 to 11.00	1.8
11.5 to 13.0	2.0
13.5 to 14.5	2.2
15.0 to 16.5	2.3
17.0 to	2.4

Note : (i) Poles set on curves/crossings or at points of extra strain should be set at least 15 cm deeper than the value given above & compacted according to PWD Spec. (This is in case of normal dry soil)

(ii) For poles at special locations/loose marshy soil or where PCC poles are likely to be subjected to GALE cyclonic storm and soil corrosion due to rains and floods or in the soils of poor bearing capacity, concrete base plate (1:3:6) of the size 450x450x75mm shall be provided at the bottom under the pole. Cement concrete muffs shall be provided as per Drawing No. DDU-255.

Poles subjected to slight side pull e.g. for service connection shall be kept straight by use of pole keys as shown in the attached sketch (No. 2). When the poles are set in firm soil, one key is put 450mm. below the ground surface on the side of strain. In loose soil a second key on the opposite side at the butt of the pole is required.

It is a well known fact that a support tends to pivot about the fulcrum point some distance below ground level. It is accordingly desirable that the poles must be set in the ground as per the details given above.

Holes for over-head pole line can be dug by means of special machines. Round holes for single pole hole are made by means of manual automatic hole auger and power driven excavation machine. Manual labour may be admitted only where the scope of work is small and suitable mechanism cannot be used because of confined space, danger of injuring adjacent installation or danger of accident.

For

# POLE KEY

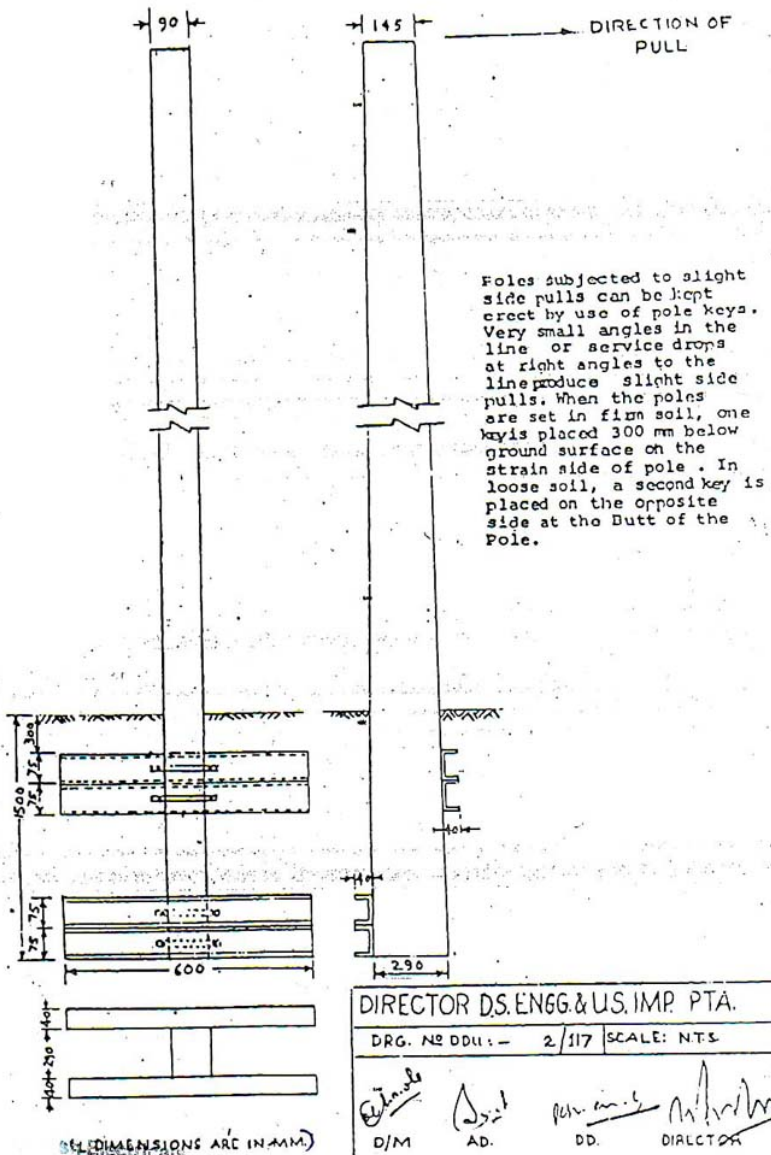

198

# FLY GUY ARRANGEMENTS

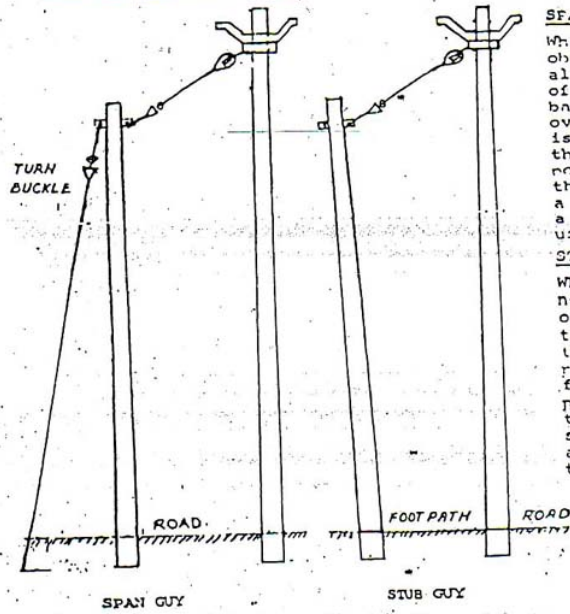

**SPAN GUY :**  
 When traffic or other obstacles do not allow direct fixation of stay at the imbalanced poles, an over-head span guy is used to transmit the force to another pole in line when those forces and in a place that allows a down guy to be used.

**STUB GUY :**  
 When a span guy can not be used because of interference with traffic and where there is no practical location for an auxiliary pole an auxiliary pole an anchor guy that would allow a span guy to be used, a stub guy may have to be used.

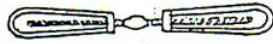





TURN BUCKLES



STRAIN INSULATORS

DIRECTOR'S ENGG & USIMP. PTA

DRG. NO. DDU- 10 SCALE. N.T.S.

 PGM  
 H.D.  
 D.D.  
 DIRECTOR



STAY DETAILS

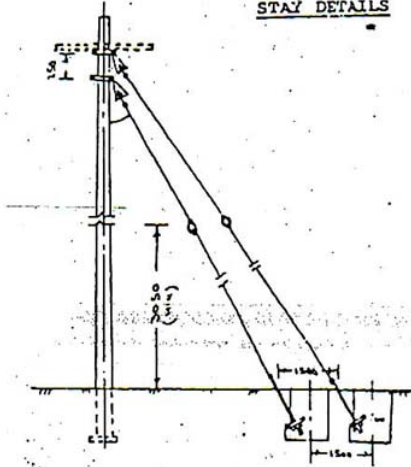

Arrangement showing double stays at heavy angles and terminations etc.  
(Max. angle of stay with vertical  $30^{\circ}$  to  $45^{\circ}$ )

DOUBLE GUY

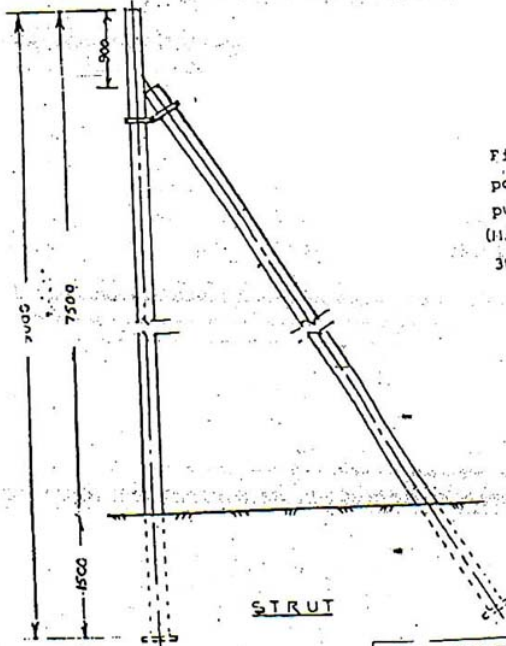

Fixing arrangement of Strut pole where stay can not be put.  
(Maximum angle with vertical  $30^{\circ}$  to  $45^{\circ}$ )

STRUT

DIRECTOR D. S. ENGG & USIMP PTA.  
DRG NO DDU-131. SCALE 1/4" = 1'-0"

D/M A.D. O.D. DIRECTOR

**DATA FOR THE DESIGN OF OVERHEAD LINES**

Sr. No.	Description of Pole	Conductor size in mm <sup>2</sup>	Max. Permissible span (Mtrs.)		Max. Permissible span (Mtrs.)		Max. Permissible span (Mtrs.)	
			11KV (REC Design) a formation with E/Wires (4mm. GI Wire hard)	4 wire, LV with Street Light & Single Earth wire (vertical formation)	Ground clear ance 4.6M (others)	Ground clear ance 5.5M along street	Ground clear ance 5.8 M. along street	Ground clear ance 5.8 M. across street
2	3	4	5	6	7	8	9	
1.	8M/140 Kg. transverse	13	Unsuitable	Unsuitable	Unsuitable	45	Unsuitable	Unsuitable
	width 90 mm REC Design	20	-do-	-do-	-do-	45	-do-	-do-
		30	-do-	-do-	-do-	Uneconomical	-do-	-do-
		48	-do-	-do-	-do-	-do-	-do-	-do-
2.	8M/200 Kg. transverse	65	-do-	-do-	-do-	-do-	-do-	-do-
	width 90 mm REC Design	13	-do-	-do-	-do-	50	Unsuitable	Unsuitable
		20	70	unusable	unusable	50	-do-	-do-
		30	70	-do-	-do-	50	-do-	-do-
3.	9M/170 Kg. transverse	48	50	-do-	-do-	35	-do-	-do-
	width 85mm PSEB W/shop design	65	50	-do-	-do-	35	-do-	-do-
		13	55	45	45	50	35	35
		20	55	45	45	50	35	35
4.	9 M/200 Kg. transverse	30	40	35	35	Uneconomical	25	25
	width 105 mm REC Design	48	40	35	35	-do-	25	25
		65	40	35	35	-do-	45	45
		13	65	50	50	55	45	35
	20	65	50	50	55	45	35	
	30	65	50	50	55	45	35	
	48	45	40	40	40	30	30	
	65	45	40	40	40	30	30	

Subject: Minutes of the meeting of the Committee constituted by the Board vide Secretary, PSEB, office order No.412/BD/G-2243/Vol.II, dated 25.3.2010 for sanctioning increase in premium from time to time on the existing Schedule of Labour Rates, hold in the Chamber of Engineer-in-Chief/TL, PSEB, Patiala on 29-3-2010.

The following were present:

1. Er. H.S. Nagpal, Engineer-in-Chief/TL, Patiala. : Member
2. Er. H.S. Randhawa, Chief Engineer/Substation, Patiala. : Member
3. Er. Tejwant Singh, Chief Engineer/Commercial, Patiala. : Member
4. Sh. Jalinder Goyal, Chief Accounts Officer, Patiala. : Member
5. Er. C.S. Mann, Dy.CE/TLSC Circle, Patiala : Secretary (Convenor)

The committee considered the proposal submitted by Dy.CE/TLSC Circle, Patiala.

The Committee observed that the increase in premium of Schedule of Labour Rates have been effected from time to time in the past on the basis of increase in emoluments of Work Charge T-Mate with respect to his emoluments at the time of last revision. The Committee considered various aspects effecting the premium including increase in wages of Work Charge staff in addition to other factors. The Committee, after deliberations/discussions, decided to revise the premium w.e.f. 1.4.2010 as under:

Sr. No.	Name of work	Existing Premium w.e.f. 01.11.2004	Revised Premium w.e.f. 01.04.2010
1.	Distribution work upto 11 KV	2720%	5300%
2.	Transmission works 33 KV and above		
	i) Stub setting	1380%	2750%
	ii) Erection of towers, stringing and sagging of transmission lines.	1380%	2750%
3.	Erection of line on Rail-pole structures	1480%	2950%
4.	Grid Sub-Station work 33 KV and above	1190%	2400%

  
 (Er. H.S. Randhawa) CE/Substation Patiala.     
 (Er. Tejwant Singh) CE/Commercial Patiala.     
 (Sh. Jalinder Goyal) CAO, Patiala.     
 (Er. H.S. Nagpal) EIC/TL, Patiala.

**Techno-Commercial Bid (Annexure-I(A) to Annexure-I(J))**

**ANNEXURE-A**

**a) General Information**

Name and Address of the Firm	
Head Office Address	
Contact Persons (With Telephone Nos. Office & Residence)	
Fax No.	
E-Mail	
Year of incorporation	
Offer Validity (Min 120 days)	
Earnest money @2% of estimated tender cost subject to a minimum of Rs 5000 and Maximum of Rs. 10.00 Lacs OR Valid PEMD of Rs 2.5 lacs.	
Valid EPF&ESI Registration Certificate	
Valid "A" Class Electrical Contractor Certificate from CEI, Punjab.	
Copy of PAN Card.	
GST Registration Certificate	
<p><b><u>Proof of Experience:</u></b> Tenderer shall submit proof of experience as a contractor or sub contractor of having successfully executed similar works of erection of EHT/HT/LT Lines/DTs etc in PSPCL,PUDA, Railways, NHAI, PWD, Public Sector Undertakings or other Govt/Semi Govt. Organization, Work of CHB as below :</p> <p>1) Experience of above completed work of aggregate value not less than amount equal to 40% of estimated tender cost each in any three years in last seven years i.e. from 2018-19 to 2024-25.</p> <p style="text-align: center;">or</p> <p>2) Experience of above completed work of aggregate value not less than amount equal to 50% of estimated tender cost each in any two years in last seven years <u>i.e. from 2018-19 to 2024-25.</u></p> <p style="text-align: center;">or</p> <p>3) Experience of above completed work of aggregate value not less than amount equal to 80% of estimated tender cost each in any one year in last seven years <u>i.e. from 2018-19 to 2024-25.</u></p> <p><u>Note:-1. Contractor/Sub contractor shall furnish any of above mentioned Experience certificate of completed work duly signed by Sr.XEN.</u></p>	

<u>2. Sub contractor must be authorized by competent authority of PSPCL,PUDA, Railways, NHAI, PWD, Public Sector Undertakings or other Govt/Semi Govt. Organization etc.</u>	
Proof of enlistment if Registered with PSPCL. If Not, Registration fee as applicable must deposit before submission of bid.	
Proof of Bank Solvency equal to 15% of estimated tender cost issued after 01-04-2025.	
Duly audited annual financial reports /average annual turnover equal to 30% of estimated tender cost in last three years <u>i.e.2022-23,2023-24 &amp; 2024-25</u> certified by Chartered Accountant <u>along with his UDIN number.</u>	
Affidavit regarding non defaulter of EPF, ESI, GST & Service Tax of last Five Years (or as applicable) & regarding non Black listing of firm by any Govt./Semi Govt./PSU of India duly attested by Executive Magistrate.	
Undertaking from the bidder that in case of award of contract to them, they shall furnish Labour License issued from Labour Deptt. Or undertaking regarding Exemption of labour licence before the commencement of work.	
Undertaking regarding Registration Under Building and Other Construction Worker Act 1996 under Section 7& 12	
Income Tax Returns of firm as well as Directors/ Partners/ Proprietor of the firm for the latest 3 years.	
Form 26 AS of the firm for the corresponding years of Experience.	
Legally valid Authorization signed by Chairman & other Directors of the firm in case of Limited Companies & by all partners in case of partnership firms authorizing the signatory to sign the tender & deal with PSPCL.	
Contractor shall furnish the performance certificate duly signed by Sr.Xen & counter signed by concerned SE.	
Price Bid duly filled up complete in all respects.	
Undertaking regarding unconditional acceptance of all terms and conditions of PSPCL.	
Undertaking regarding signing of all Tender Documents.	

**Note:**

- 1 Relevant supporting documents must be uploaded on website <https://eproc.punjab.gov.in>  
Detailed information regarding Tenders can be downloaded from the website <https://eproc.punjab.gov.in>
- 2 It is informed that in case tender process is not completed due to any reason, no corrigendum will be published in newspapers. Details regarding corrigendum may be seen on official, PSPCL Website. [www.pspcl.in](http://www.pspcl.in)

- 3 If any documents uploaded by the bidders s found bogus/fake at any later stage, action will be taken against such firm as per rules and regulations of PSPCL.
- 4 If any document remains un-uploaded by the bidder, no such document will be accepted later on at any cost. Only such documents uploaded by the Bidders will be accepted on the basis of which evaluation of bidders be accounted for.

**Date:**  
**Place:**

**SIGNATURE OF BIDDERS**

**NAME:**  
**Designation and Seal:**

**Experience and Turnover**

This includes the Bidder experience in handling similar kind of works in various Govt. / Semi Govt. organizations. Bidder should submit satisfactory performance certificate from various utilities in respect of experience in execution of similar works. The firm should not have been blacklisted by any central / state / public utility at the time of submission of bid.

The details may be given in Performa given below. The bidder may also use his own Performa if he wants to provide additional information

Sr. No	Name of office (Govt./Semi-govt)	Financial Year	Nature of Work	Contract value as per work order	Amount of Successfully executed work

Note: a) Relevant supporting documents may be attached.

**DEVIATION SCHEDULE**

Bidder shall carefully state below any and all points in this proposal which are not in accordance with PSPCL's Technical Specification and the General Instructions: -

Sr. No.	Para no.	Technical Deviation, if any.
1. 2. 3. contd...		
Sr. No.	Para no.	General/Commercial Deviation, if any.
1. 2. 3. contd...		

We hereby certify that the above mentioned are the only deviations from Purchaser's aforesaid specifications and general conditions.

**Note:** The bidder is to clearly indicate any deviation in technical & general terms and conditions in this Annexure only. In case, the Technical Specification as well as General conditions of Tender Specifications are acceptable in to the word 'NIL' shall invariably be put in the above Columns. In case, nothing is mentioned here then it shall be presumed that there is no deviation in the offer and terms and conditions of the specifications are acceptable to the bidder in to.

**ABSTRACT OF TERMS AND CONDITIONS**

(To be filled online)

- |     |  |          |
|-----|--|----------|
| 1.  | Earnest Money Deposit  |          |
|     | a. Contractor Draft details  |          |
|     | b. Proof of deposit of cash, if deposited  |          |
| 2.  | Processing Fee –   | Yes / No |
|     | Minimum Rs. 1000/- to Maximum Rs. 10000/-  | Yes/ No  |
| 3.  | Validity (120 days)  | Yes/ No  |
| 4.  | Terms of Payments  |          |
|     | whether agreeable to PSPCL's terms   | Yes / No |
| 5.  | Schedule date of Completion  |          |
|     | whether agreeable to PSPCL's terms   | Yes / No |
| 6.  | Guarantee  |          |
|     | whether agreeable to PSPCL's terms   | Yes / No |
| 7.  | Penalty  |          |
|     | whether agreeable to PSPCL's terms   | Yes / No |
| 8.  | Whether agreed to technical specifications /<br>scope / objective of work and drawings | Yes / No |
| 9.  | Whether photo copies of clearances from<br>Income tax department have been enclosed    | Yes / No |
| 10. | Whether registered with PSPCL  | Yes /No  |

If No Registration fee as applicable must deposit before online submission of Tender documents.

**DATE:** (SIGNATURE OF AUTHORIZED REPRESENTATIVE)

**PLACE:**

**NAME:**

**DESIGNATION & SEAL:**

AFFIDAVIT

I, ..... S/o Sh. .... R/o  
H.No....., do  
hereby solemnly affirm and declare on oath as under: -

1. That I am permanent resident of above given address.
2. That the firm had not been defaulter in respect of deposition of Service Tax, EPF, ESIC, GST etc.to the concerned department for the workers deployed against work orders placed by PSPCL on it during the last five years. In any case the responsibility for deposition of GST, Service Tax, EPF, ESIC of the workers engaged by the firm shall lie with the firm only. In case the firm is found defaulter at any stage in this regards the contract shall be cancelled/Terminated without any notice.
3. That nothing is due towards our A/c No..... of EPF. The firm has cleared all the EPF dues upto-date.
4. That the firm M/s..... is **not Blacklisted/Debarred** by any Government/Semi Government/Public Sector/PSPCL.
5. That my above given statement is true and correct.

DEPONENT

VERIFICATION:

Verified that the contents of my above affidavit are true and correct to the best of my knowledge and belief and nothing has been concealed therein.

Place:

Date:

DEPONENT

**UNDERTAKING**

I,.....Prop/Partner/Director of M/S.....undertake that I/We/shall furnish labour license certificate from labour deptt. as per labour laws before commencement of work.

OR

I,.....Prop/Partner/Director of M/S.....undertake that I/our firm is exempted from labour license certificate from labour deptt. as per labour laws.

**UNDERTAKING**

I, .....Shall furnished/uploaded the registration certificate of the firm under section 7 of the building and other construction workers (Regulation of Employment and Conditions of Service) Act, 1996.

I,..... also undertake that I shall comply with the section 12 of the building and other construction workers (Regulation of Employment and Conditions of Service) Act, 1996 by registering all the workers to be engaged for the work as per the act before the commencement of work.

**ANEXURE-H**

**From: Addl.SE/DS**

**To,**

**M/s.....**

**.....**

**Subject: Work Experience Certificate.**

**Memo No:**

**Dated:**

**It is certified that M/s..... has successfully executed the following works in the various subdivisions falling under this division. His work is satisfactory.**

<b>Sr.No</b>	<b>Name of Divn.</b>	<b>Year</b>	<b>W/o No &amp; Date</b>	<b>Successfully completed/ Executed Amount of Work Order</b>
<b>1.</b>				
<b>2.</b>				
<b>3.</b>				
<b>4.</b>				
<b>5.</b>				
<b>6.</b>				
<b>7.</b>				
<b>8.</b>				
<b>9.</b>				
<b>10.</b>				

**Addl.SE/DS,**

**.....**

**C/S**

**SE/Ds,**

**.....**

**GOODS AND SERVICES TAX**

**PSPCL is registered centrally in the state of Punjab under GSTIN:  
03AAFCP5120Q1ZC**

- Certified that the transaction on which GST is claimed has been/shall be included in the return submitted/to be submitted under GST law and the amount claimed from PSPCL has been deposited/shall be deposited with GST authorities.
- Certified that the supplies on which GST has been charged have not been exempted under GST Act or rule made there under and that GST charged on these supplies is not more than what is payable under the provisions of relevant act.
- Certified that we shall indemnify the PSPCL, in case, it is found at a later stage that wrong or incorrect payment has been received on account of GST, the same will be refunded.
- Certified that we registered under GST Act our registration no is:  
\_\_\_\_\_
- Further any loss due to non-availability of ITC of levy of penalty/interest payable by PSPCL on account of non-filing of return or non-compliance or any miss-statement given under the provisions of GST Act by the contractor shall be recoverable from them.

**Signature of Contractor  
Or  
Authorized representative of the firm.**



**PUNJAB STATE POWER CORPORATION LTD**  
 (Regd. Office P.S.E.B., CIN-U40109PB2010SGC033813, The Mall Patiala-147001)  
**Deputy Secretary/ Industrial Relations, Patiala**  
Mobile No. 096461-55502 Fax No. 0175-2215897 Email:irsectionpspcl@gmail.com

Office order No. 10

I.R.O.- 676

Dated: 8/12/23

PSPCL is engaged in providing un-interrupted power supply to its valuable consumers. In this process certain activities may be engaged which are hazardous to human life. PSPCL has been paying compensation to its Regular employees, Contractual employees, Contractor's workers and Private persons in case of fatal/non-fatal accidents occurring during the course of employment & in employment, irrespective of the fact that the accident has occurred due to electrocution or otherwise and private persons have also been paid compensation in the case of fatal/ non-fatal accidents occurring due to electrocution on PSPCL's electric network for the negligence on the part of PSPCL in accordance with various statutory provisions and regulations.

It has been felt that a comprehensive accidental compensation policy be framed. The salient features of this policy are as under:

1. **Type of Accidents:** Depending upon the severity of the accident and its impact on human beings, the accidents are classified as under:-

- I. **Fatal accident:-** Resulting into the death of human beings.
- II. **Non-Fatal Accidents:-** Resulting into disability to human beings.

Depending upon the disability, these non-fatal accidents are further classified as under:-

- (a) Accidents resulting in permanent disability.
- (b) Accidents resulting in partial disability.
- (c) Accident resulting in temporary disability.

**Explanation:** An accident means :

- (a) **For Regular employees, Contractual employees & Contractor's workers-**  
A Fatal/ Non-fatal accident occurring during the course of employment & in employment, irrespective of the fact that the accident has occurred due to electrocution or otherwise.
- (b) **For a private persons-**  
A fatal/ Non-fatal accident occurring due to electrocution on PSPCL's electric network.

Provided that an accident occurring due to negligence and willful act of a private person shall be excluded from this policy.

**2. Category of the affected person:-**

The affected category of persons covered under this policy is as under:-

- i. Regular employees of PSPCL
- ii. Contractual workers directly hired by PSPCL.
- iii. Contractual workers hired by contractors/outsourced agencies for executing PSPCL's works.
- iv. Private Persons :
  - (a) Adult
  - (b) Minor ( whose age is less than 16 years )

**3. Compensation under this scheme for various categories of affected persons is as under:**



**A. PSPCL's Regular Employees:**

FATAL ACCIDENT	NON FATAL ACCIDENT
<p>1. Payment of compensation in accordance with the provisions of Employee's Compensation Act, 1923.</p> <p style="text-align: center;">OR</p> <p>Payment of Ex-gratia amounting to Rs. 10.00 Lac in accordance with finance circular No. 20/21 read with Secretary PSEB Patiala Circular Memo No. 26943/ 27565/ Spl. 3 dated 08.02.1974</p>	<p>1. Provision regarding payment of Disablement compensation in accordance with the provisions of Employee's Compensation Act, 1923.</p> <p style="text-align: center;">OR</p> <p>Payment of Ex-gratia amounting to Rs. 10.00 Lac in accordance with finance circular No. 20/21 read with Secretary PSEB Patiala Circular Memo No. 26943/27565/Spl. 3 dated 08.02.1974</p>
<p>2. Accidental Group Insurance amounting to Rs. 1.00 Lakh in accordance with Joint Secy./ Personnel office Memo no. 20872/22281 dt. 02.03.2007.</p>	<p>2. Provision regarding advance payment for cost of treatment up to 80% (in private /Govt. Hospitals) in accordance with Deputy Secy / P&amp;R memo no. 72216/ 416/ REG/16/Loose-2 dated 20/7/2011.</p> <p>3. Service benefits as provided under Persons with Disabilities (Equal Opportunities, Protection of Rights, and Full Participations) Act, 1995.</p>



It has been decided to extended facility of providing medical advance for the treatment of injured employee immediately after occurrence of accident. For this purpose competency will be as under:

- (a) Sr.Xen - Upto Rs. 1,00,000/-
- (b) SE - Upto Rs. 2, 00,000/-
- (c) CE - Upto Rs. 3,00,000/-

- The concerned Sr.Xen/ DDO shall satisfy himself before disbursement that the amount being disbursed is genuine and in accordance with the requirement of treatment.
- The medical advance paid as above will be recovered from the medical bills submitted by the victim for reimbursement.
- In case the victim dies during the treatment, then on presentation of the medical bills by the legal heirs of the victim, medical advance paid as above shall be adjusted against the medical re-imburement.

Provided in case the employee dies during the treatment, if the reimbursement amount falls short of the medical advance then the shortfall of medical advance shall not be recovered from the Death-cum - Retiral benefits and the same may be got written off from the competent authority i.e. CMD, PSPCL.



**B. Contractual Workers (Directly hired by PSPCL)**

<b>FATAL ACCIDENT</b>	<b>NON FATAL ACCIDENT</b>
<p>1. Provision regarding payment of ex-gratia amounting to Rs 10 Lakh in case of death due to an accident occurring during the course of employment and in employment (as per decision of the BODs dt. 25/10/2023).</p>	<p>1. (a) In case of non-fatal accident resulting into 100% permanent disability, a lump-sum compensation amount of Rs. 10.00 lac as Ex-gratia. (b) If the disability is less than 100% then compensation shall be paid on pro rata basis depending upon the percentage of disability.</p>
<p>2. Group insurance of Rs. 10.00 Lakh (as per decision of the BODs dated. 25/10/2023).</p>	<p>2. Disablement benefits as per terms and conditions of the group insurance.</p>
<p>3. Dependent benefits (family pension) to the legal heirs of the Deceased in accordance with the provisions of Employees State Insurance Act, 1948.</p>	<p>3. Treatment / Reimbursement of medical expenditure and Disablement benefits (Both temporary and permanent disablement as per Employees State Insurance Act, 1948.</p>

**C. Contractor's workers (through contractors/outsourced agencies)**

<b>FATAL ACCIDENT</b>	<b>NON FATAL ACCIDENT</b>
<p>1. Payment of Ex-gratia amounting to Rs. 10 Lac in case of death due to an accident occurring during the course of Employment and in employment (As per BODs decision dated 25.10.2023).</p>	<p>1. (a) In case of non-fatal accident resulting into 100% permanent disability, a lump-sum compensation amount of Rs. 10.00 lac as Ex-gratia. (b) If the disability is less than</p>



<p>2. Group Insurance 10 lacs as per the terms and conditions of the contract. (As per BODs decision dated 25.10.2023 )</p> <p>3. Dependent benefits to the legal heirs of deceased in accordance with the provisions of Employees State Insurance Act, 1948.</p>	<p>100% then compensation shall be paid on pro rata basis depending upon the percentage of disability.</p> <p>2. Disablement benefits as per the terms and conditions of Group Insurance.</p> <p>3. Treatment/ Reimbursement of medical expenditure and disablement benefits (Both for temporary and permanent disablement as per Employees State Insurance Act, 1948).</p>
---	---

**D. Private Person (Adult)**

<b>FATAL ACCIDENT</b>	<b>NON FATAL ACCIDENT</b>
Payment of compensation In accordance with the provisions of Employees compensation Act, 1923 as per PSPCL's Delegation of Powers Regulation No.130.	Payment of disablement compensation In accordance with the provisions of Employees compensation Act, 1923 as per PSPCL's Delegation of Powers Regulation No.130



**E. Private Person ( Minor, means whose age is below 16 yrs. of age)**

<b>FATAL ACCIDENT</b>	<b>NON FATAL ACCIDENT</b>
Payment of compensation in accordance with the provisions of Employee's Compensation Act, 1923. Considering the victim as above 16 years of age.	Payment of disablement compensation in accordance with the provisions of Employee's Compensation Act, 1923, considering the victim as above 16 years of age.

**Note:** Since, the age factor for person having age less than 16 years is not available in the Employees Compensation Act 1923, accordingly, the age factor for the 16 years (being the highest age factor) shall be considered for working out the amount of compensation.

4. The authority to sanction the compensation under the above policy shall be as provided under PSEB delegation of powers.

**5. Procedure for compensation (For Regular Employees):**

A. It will be the responsibility of the SDO concerned to obtain following relevant documents to process with fatal/ non-fatal accidents compensation cases and shall submit to Sr.XEN within 15 days:-

- (i) Copy of FIR/Police Panchnama/DDR
- (ii) Copy of Post Mortem report.
- (iii) Investigation report of CEI.
- (iv) Duty certificate.
- (v) Claim application of authorized legal heir of the deceased.
- (vi) Disability Certificate issued by competent authority.



B. Concerned XEN will verify above documents & submit the case to concerned SE along with the following documents within 7 days:

- (i) DOB as per service book.
- (ii) Last Pay Drawn Certificate.
- (iii) Recommendation of compensation.

C. Concerned SE will forward the case to CE along with his recommendation of compensation within 04 days.

D. CE will approve the compensation under Employee's Compensation Act, 1923.

E. The entire process of the payment of compensation will be completed within 30 working days from the date of receipt of the application.

6. **Procedure for final compensation (For Contractual Employees directly hired by PSPCL) –**

A. **Ex-gratia :**

The claim for Ex-gratia will be presented to Deputy Secretary/IR in terms of SE/Personnel, PSPCL, Patiala Memo no. 56950/57900 ENG-2/loose/2/8/19 dt 17.9.19.

B. **Compensation:**

- (i) For claiming compensation Under ESI Act 1948, the concerned officer in-charge shall take up the matter with ESI authorities for sanctioning of the compensation to the deceased/Victim by procuring the relevant documents as required by ESI authorities.
- (ii) In case the worker has not been registered under ESI Act 1948, then his case for compensation shall be considered as per



Employee's Compensation Act, 1923 in accordance with the procedure detailed out in Para no. 5 above.

C. **Group Insurance:**

On the receipt of the relevant documents from the victim/family of the deceased, the concerned officer in-charge shall get the claim for Group Insurance settled from the company through which the insurance has been taken.

7. **Procedure for final compensation (For Workers hired through Contractors/ Outsourced agencies).**

A. **Ex-gratia :**

(i) For contractual workers (other than CHB), the claim for Ex-gratia will be presented to Deputy Secretary/IR in terms of SE/personnel PSPCL Patiala memo no. 56950/57900 ENG-2/loose/2/19 dt 17.9.19 and BOD's decision dated 25.10.2023

(ii) For contractual workers (CHB) the amount of ex-gratia will be released by the concerned contractor immediately after the occurrence of accident, preferably before completion of the last rites of the victim. In case of his failure to do so PSPCL will grant the amount of ex-gratia from its own funds to the next kin of the victim and recover the amount from the outstanding payable to the contractor.

B. **Group Insurance :**

On the receipt of the relevant documents from the victim/family of the deceased, the concerned contractor/outsourced agency



shall get the claim for Group Insurance settled from the company through which the insurance has been taken.

C. **Compensation:**

- (i) For claiming compensation Under ESI Act 1948, the concerned officer in-charge shall take up the matter with ESI authorities for sanctioning of the compensation to the deceased/Victim by procuring the relevant documents as required by ESI authorities.
- (ii) In case the worker has not been registered under ESI Act 1948, then his case for compensation shall be considered by PSPCL being "Principal Employer" as per Employee's Compensation Act, 1923 in accordance with the procedure detailed out in Para no. 8 above.

Provided that the compensation amount so paid shall be recovered from any amount payable to the contractor and if no amount is outstanding against the contractor, then the amount so paid shall be recovered by filling civil suit against the contractor/outsourced agency.

8. **Procedure for final compensation (For Private Persons).**

A. On receipt of the application, it will be the responsibility of the concerned SDO to obtain relevant documents such as:

- (i) Copy of FIR/ Police Panchnama/DDR
- (ii) Copy of Post Mortem Report.
- (iii) Proof of age of the deceased/Victim



- (iv) . Proof of income such as salary certificate of employer, Panchayat Certificate of Income for Rural area and from Municipal Corporation for Town area or from any other Competent Authority.
  - (v) Chief Electrical Inspector's (CEI) investigation report.
  - (vi) Disability Certificate issued by competent authority.
- B. For all eligible cases, the concerned SDO shall submit the documents to Sr.XEN concerned.
- C. Concerned Sr.XEN will verify all the documents and satisfy himself that the death of the victim was caused by electric shock in PSPCL's Electrical Infrastructures or equipment's and not in private premises. He shall further ensure that the accident with private person has not occurred due to his own negligence. Thereafter, he will finally submit the case to the Circle office.
- D. Concerned SE shall forward the case along with his recommendation for compensation within 04 days to Chief Engineer. CE will take decision on payment of compensation accordingly.
- E. The entire process of the payment of compensation will be completed within 30 working days.

**NOTE:-**

- (i) The purpose of report of Chief Electrical Inspector (CEI) is to ascertain the cause of accident for taking remedial measures to avoid accidents in future. However, for sanction of compensation by competent authority, the report of Chief Electrical Inspector (CEI) is not mandatory requirement in all categories.



- (ii) The provisions for compensation as provided in this policy are not exhaustive. The victim or his legal heirs will be entitled for additional compensation as provided in any law for the time being in force.
- (iii) All the pending cases of accidents occurring due to electrocution with private person shall be considered under this policy and disposed of as provided herein.
- (iv) For any ambiguity regarding interpretation/ amendment of this policy, Deputy Secy./IR shall issue necessary clarification.

This has been issued with the approval of competent authority.

  
Manager/IR  
PSPCL Patiala

Endst. No. 5599/6036 I.R.O. - 676 Dated: 8/12/23

Copy of above is forwarded to the following for information and

further necessary action:-

1. DGP/ V&S , PSPCL, Patiala.
2. All GMs, Er-in- Chiefs, CEs, PSPCL/PSTCL.
3. Cost Controller, Chief Auditor, CFO, Financial Advisor, PSPCL.
4. All CAOs, PSPCL, Patiala.
5. Dy. CEs, SEs , Dy. CAOs, Legal Advisor, PSPCL.
6. All Addl. SEs, Manager/HR, Dy. Secys, PSPCL.
7. All AEEs , Under Secy., Dy. Manager/HR, PSPCL.
8. All AOs, AEs/, AM/HRs/IRs, Supdt. Gr-1, PSPCL.

  
Manager/IR  
PSPCL Patiala

Endst. No. 6087/44 I.R.O. -676 Dated: 8/12/23

Copy of above is forwarded to the following for information please:-

1. Sr. PS to Principal Secretary/Power, Govt. of Punjab Chandigarh.
2. Sr. PS to CMD, PSPCL/PSTCL, Patiala.
3. Sr. PS to Dir/Admin, PSPCL, Patiala.
4. Sr. PS to Dir/Distribution, PSPCL, Patiala.
5. Sr. PS to Dir/Commercial, PSPCL, Patiala.
6. Sr. PS to Dir/HR, PSPCL, Patiala.
7. Sr. PS to Dir/Generation, PSPCL, Patiala.
8. Sr. PS to Dir/Finance PSPCL, Patiala.

  
Manager/IR  
PSPCL Patiala

**ANNEXURE-II**

**PRICE BID**

**Tender Enquiry No. 12/West Circle/Ldh/Unit-1 Model Town/2025-26**

Sr. No	Description of Works	Premium over SLR to be Quoted by the Bidder (Exclusive of GST) (In %)
1	Outsourcing of Labour Part for replacement of low-lying PVC at road crossings with 4-core cables and re-locations of MCB's., maintain line symmetry and proper ground clearance, replace existing 8-meter PCC poles with 9-meter PCC poles, replace 1/1 MCB near road crossings with 4/1 MCB to reduce congestion of PVC cables & replacement of multiple 4 core road crossing cables with single higher size 4 core cables, any other labour work related to provide better electrical clearance.	Scheduled Labour Rate + Premium.....%

- Value of Premium Should be entered in numeric only (without using % key).

**Note:**

1. Status of L-1 firm will be decided on the basis of SLR Quoted by firm. However premium over SLR and steel fabrication rates shall be negotiable, if necessitated, with L-1 firm.
2. The Quoted rates include any fabrication works at etc., required to completely scope of work. No additional fabrication charges will be payable by PSPCL.
3. All the material shall be supplied by the PSPCL.
4. Any quantity of work can be increased/decreased depending upon actual site conditions.
5. The bidder shall quote FIRM, FOR % premium on PSPCL Scheduled Labour Rates inclusive of all taxes (except GST). GST shall be paid extra.
6. Any statutory increase/decrease in Taxes shall be to the account of PSPCL.
7. The work shall be carried out as per sketches/guidelines supplied by respective Sr.Xen/Addl.SE Op. Divisions under DS City West Circle Ludhiana or any higher authority of PSPCL. The work shall be completed as per norms of the PSPCL.
8. Dismantled material if any, shall be returned by the Contractor to store within 15 days of the completion of work through JE concerned. Transportation shall be provided by the Contractor without any extra cost.
9. PSPCL reserves the right to cancel the tender process at any stage without assigning any reason thereof. No corrigendum in this regard will be published in newspapers. Details regarding corrigendum may be seen on Punjab Govt. site. <https://eproc.punjab.gov.in>
10. Copy of PSPCL Scheduled Labour Rate, If required can be obtained from this office.
11. PSPCL reserves the right to allocate the tender to L-1 or more bidders at its discretion.

I / We have read all the terms and conditions of the NIT and quoted out Rates as above in accordance with the stipulated terms and conditions.

**Signature of Contractor  
or authorized representative of the firm**

**CONTRACT AGREEMENT FORM**

( To be entered on a Non Judicial Stamped Paper Of Rs 500/- Only)

This contract agreement made this \_\_\_\_\_ day of \_\_\_\_\_ in the year \_\_\_\_\_ between the Punjab State Power Corporation Ltd., here-in-after called Purchaser and M/s. \_\_\_\_\_ have their Registered office/ works at \_\_\_\_\_ here-in-after called contractor for \_\_\_\_\_ in accordance with NIT No. \_\_\_\_\_ due on \_\_\_\_\_ and contractor's proposal No. \_\_\_\_\_ dated \_\_\_\_\_.

This is in confirmation of the advance acceptances notified in the owner's letter No. \_\_\_\_\_ dated \_\_\_\_\_ wherein the Owner has accepted the proposal of the \_\_\_\_\_ as per Work Order No. \_\_\_\_\_ dated \_\_\_\_\_.

In view of the forgoing, the purchaser and the contractor have agreed to the scope of work and the terms and conditions of the order settled between them.

The NIT/Tender specification the contractors Proposal and related correspondence and the Work Orders acknowledged/accepted by the contractor form part of this agreement.

This agreement contains .....Pages.

In witness whereof the parties here to have affixed their signatures on the day month and year written as above.

Contractor

Owner